

EPOQUE
by
EGON FURSTENBERG



L'atmosfera... seducente e raffinata, è l'elemento base che caratterizza il nuovo spirito della griffe. Una collezione all'insegna della rivisitazione dei mobili classici, che pur riadattandoli lasciano immutato lo spirito di un tempo: ecco allora che ogni pezzo nasce da un'instancabile curiosità, attenta a tutte le espressioni di eleganza. Prerogativa della collezione è quella di porre particolare cura agli effetti più ricercati, al gioco delle proporzioni e quello degli effetti cromatici. Una qualità che ha il pregio di non far mai diventare sorpassato un modello, ma che anzi, accostato a creazioni più recenti, mostra tutta la sua capacità di vivere in ogni tempo e nei modi più diversi di arredare e decorare.

The atmosphere... tempting and refined, is the basic element that characterizes the new spirit of the designer. It is a collection that revisiting the classical furniture by constantly reinventing it while leaving the spirit of yesteryear untouched. Each piece is created from a tireless curiosity, focused on the expression of elegance. Prerogative of collection is that made particular attention has been paid to the most sought-after effect, the interplay of proportion and colour. This quality means that no piece will ever surpass another, but that rather a comparison between more recent creations, will showcase the of a piece to exist in every period of time and in the most diverse furnishing and decorating styles.

Атмосфера... обольстительная и изысканная характеризует новый вектор развития бренда. Коллекция выступает под знаком переосмысления классики, сохраняя при этом неизменным дух прошлых времен: каждый предмет рождается благодаря неутомимому любопытству и стремлению выразить элегантность. В коллекции особое внимание обращается на модные эффекты, игру пропорций и цветовую гармонию, а высокое качество и стиль позволят моделям оставаться актуальными в любое время, в разнообразных отделках и интерьерах.

DIVANI



ADENIA 16



AMARANTO 106



ANEMONE 100



BUGOLA 124



CHANTAL 22



CLEMATIDE 8



FUMARIA 148



GALLIO 44



HENRY 58



KELLY 112



LIMARIA 64



MUSCARI 92



NISSOLIA 132

DIVANI



ONONIDE 78



OSSALIDE 30



PARODIA 84



POLIGALA 144



REBUTIA 118



ROMICE 72



SILENA 138



STACHIS 28



TAJOLA 38



VERBASCO 52

POLTRONE



AGAVE 70



ANEMONE 104



FALASCO 15



INULA 37



IXORA 98



PERVINCA 29

POUF



FARFARO 110



INULA 36



PARODIA 91



SEDUM 90



ZINIA 14

DORMEUSE



EUFORBIA 50



LIGHTS 156



ACCESSORIES 160

FINISHES 188

TECHNICAL DRAWINGS 191

CLEMATIDE





CLEMATIDE



rivestimento: 41GL6183 CAT.C; cordolo: 41ES6159 CAT.C mazza Florence; passamaneria: cordone in viscosa;
cuscini: ART.055 41GL6198 CAT.L e ART.102 41GL6208 CAT.G mazza Florence





ZINIA

A - rivestimento: 41ES6159 CAT.C
mazza Florence;
passamaneria: cordone in viscosa

B - rivestimento: 40VI5588 CAT.F
mazza velluti e sete;
passamaneria: cordone in viscosa

C - rivestimenti: 40VI5588 CAT.F
mazza velluti e sete;
40GL6208 CAT.G
mazza Florence
passamaneria: cordone in viscosa



FALASCO

rivestimento: 40VI5588 CAT.F mazza velluti e sete; finitura: col.23 noce scuro

ADENIA





ADENIA



rivestimento: 40VI5586 CAT.F mazza velluti e sete; seduta: 41MC6043 CAT.C mazza Prince XII;
bordino: 40VI5586 CAT.F mazza velluti e sete; cuscinetti: ART.A46 41MC6043 CAT.C; ART.A45 41MC6045
CAT.C mazza Prince XII; copribraccioli: 41MC6043 CAT.C mazza Prince XII; bordino: 40VI5586 CAT.F mazza
velluti e sete; passamaneria: in cotone; finitura: col.21 noce medio



CHANTAL





CHANTAL



rivestimento: 41ES6152 CAT.D; fascia seduta, fascia spalla, biscotti e bordini: 41ES6143 CAT.B mazza Florence;
finitura: COL.42 ceruse' seppia





STACHIS

rivestimento: 40VI5578 CAT.F mazza velluti e sete



PERVINCA

rivestimento: 41GI6182 CAT.C mazza Florence; passamaneria: fiocchi ART.35193 COL.9350;
coccarde: ART.36015 COL.9350; bordo: ART.32151 COL.9350 collezione Palais Royal

OSSALIDE





OSSALIDE



rivestimento: 40PR5947 CAT.F; biscotti: 40PR5942 CAT.F; bordino: 40PR5943 CAT.F
mazza Chantilly; cuscini: ART. B84 41ES6147 CAT.C; ART. B85 41ES6159 CAT.C mazza Florence;
ART. 052 40PR5943 CAT.F; ART. B90 40PR5942 CAT.F mazza Chantilly; finitura: nero opaco





INULA pouf

rivestimento: 41ES6147 CAT.C mazza Florence; parte capitonè: 40PR5949 CAT.F mazza Chantilly; finitura: nero opaco



INULA

rivestimento: 41ES6147 CAT.C mazza Florence; braccioli, sponda superiore e bordino: 40VI5588 CAT.F mazza velluti e sete

TAJOLA





TAJOLA

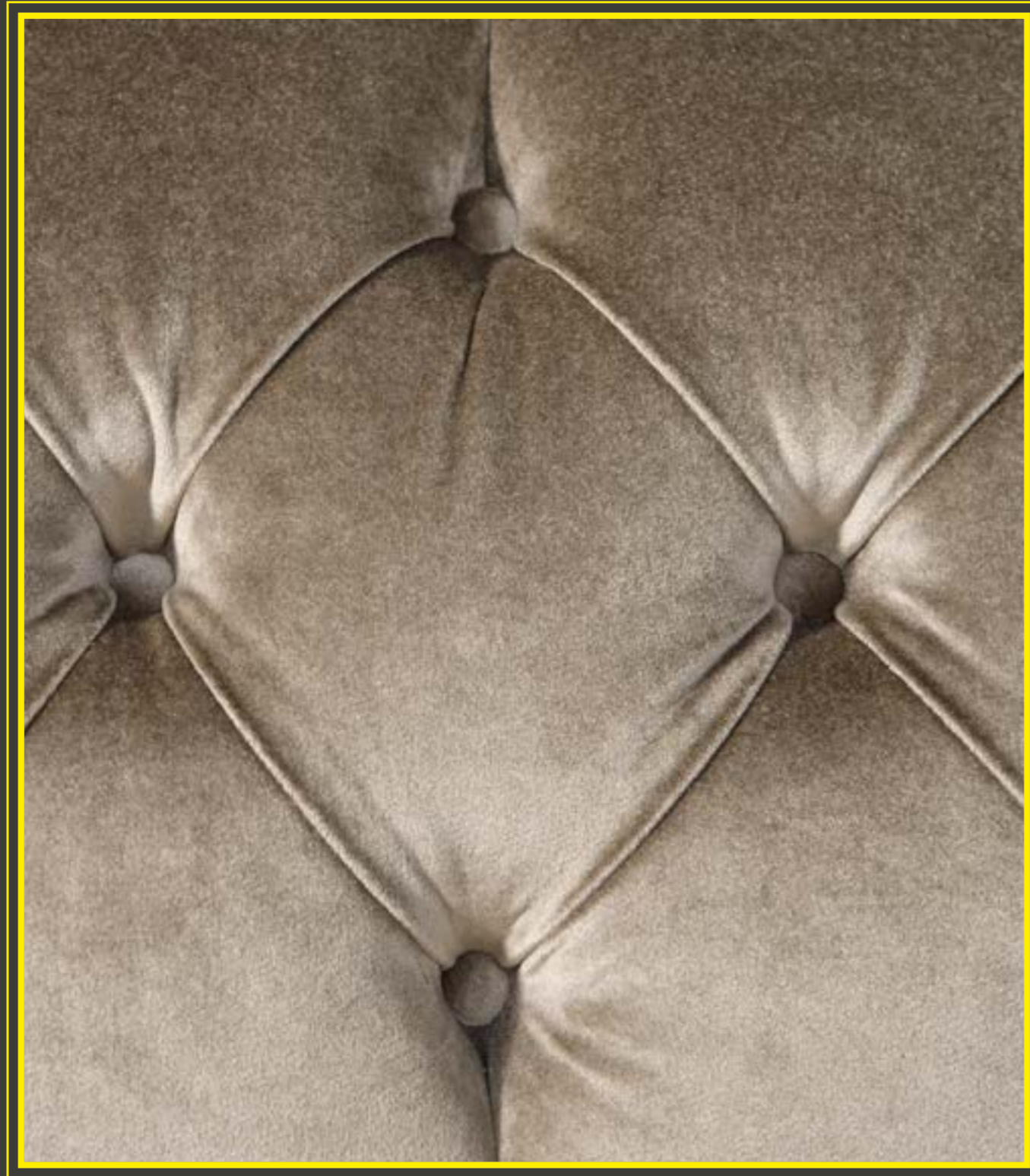

rivestimento: 41GL6183 CAT.C mazza Florence; finitura: nero opaco



GALLIO





GALLIO



rivestimento: 40HO5497 CAT.D mazza velluti e sete; seduta: 41ES6145 CAT.C mazza Florence;
passamaneria: cordone in viscosa; frangia sfilata in tinta tessuto; ART.33097 COL.9020 collezione Palais Royal;
cuscinetti: ART. C03 41ES6162 CAT.D mazza Florence



EUFORBIA



rivestimento: 40MC5544 CAT.D mazza velluti e sete; finitura: COL22 noce chiaro



VERBASCO

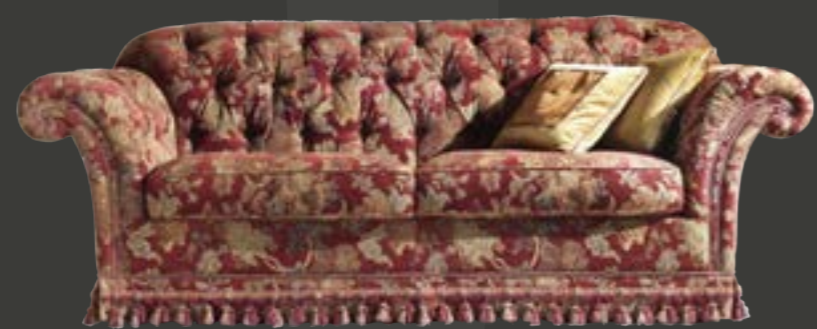



VERBASCO



rivestimento: 41FU6172 CAT.G; cuscinetti: ART. B96 41GL6181 CAT.C e 41GL6182 CAT.C; ART. B 97 41GL6181 CAT. C mazza Florence; passamaneria: cordone ART.1200 COL.5; trinetta ART.1201 COL.5; fiocchettata ART.1204 COL.5 collezione Calde Atmosfere



HENRY







rivestimento: 40PR5949 CAT.F mazza Chantilly



LIMARIA







LIMARIA

rivestimento: 41PR5723 CAT.F mazza Prince XI; ricamo: disponibile in qualsiasi colore

AGAVE



rivestimento: 40PR5833 CAT.F; interno braccioli: 40PR5948 CAT.F mazza Chantilly
finitura: COL.42 cerusè seppia



ROMICE







ROMICE

rivestimento: 40HO5497 CAT.D mazza velluti e sete; fascia seduta e fascia braccioli: 41ES6158 CAT.C mazza Florence



ONONIDE





ONONIDE



rivestimento: 41GL6179 CAT.C mazza Firenze; finitura: COL.24 foglia argento



PARODIA





PARODIA



rivestimento: 41GL6183 CAT.C mazza Florence; passamaneria: cordone ART.1401 COL.3 collezione Rosa dei Venti;
focchettata ART.1407 COL.3 collezione Rosa dei Venti; frangia sfilata in tinta con il tessuto





SEDUM

rivestimento: 41GL6183 CAT.C mazza Florence; chiodini: 40238 cream



PARODIA pouf

rivestimento: 40FB5855 CAT.F; 40FB5856 CAT.D mazza Chantilly; finitura: COL.23 noce scuro

MUSCARI







MUSCARI

rivestimento: 41GL6179 CAT.C mazza Florence; finitura: COL.23 noce scuro



IXORA



rivestimento: 41MC6013 CAT.G mazza Prince XII; cordolo: 41GL6179 CAT.C mazza Florence;
passamaneria: frangia in cotone; cordone: ART.1010 COL.1 collezione Aida



ANEMONE







ANEMONE

rivestimento: 41ES6139 CAT.D mazza Florence; finitura: COL.47 crema



AMARANTO







FARFARO

rivestimento: 41ES6151 CAT.D; cuscino: 41FU6175 CAT.G mazza Florence; passamaneria: trinetta in cotone; cordone: ART.31249 COL.9900 collezione Valmont; fiocchettata: ART.33025 COL.9900 collezione Valmont; finitura: nero opaco



AMARANTO

rivestimento: 41ES6138 CAT.D; fascia seduta: 41ES6140 CAT.B mazza Florence; passamaneria: cordone ART.1401 COL.3 collezione Rosa dei Venti; cuscinetti ART. B98 41ES6151 CAT.D; finitura: nero opaco

KELLY





KELLY



rivestimento: 41GL6198 CAT.L; biscotti e poggiatesta: 41GL6188 CAT.L mazza Florence;
passamaneria: ART. 1406 COL.3 collezione Rosa dei Venti



REBUTIA





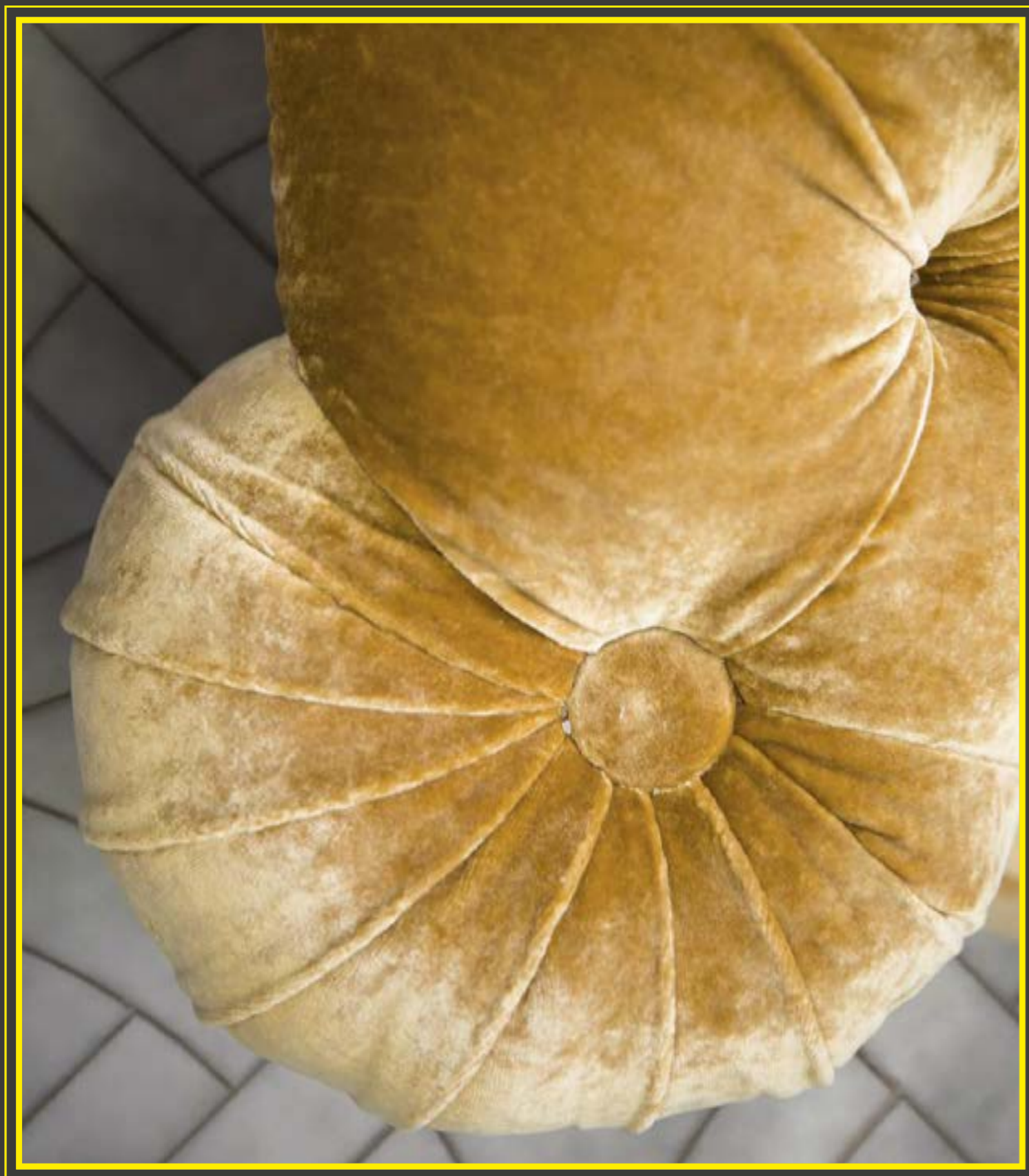

REBUTIA

rivestimento: 41GL6181 CAT.C mazza Florence; passamaneria: frangia e fiocchettata in cotone



BUGOLA







BUGOLA

rivestimento: 41VI4094 CAT.E mazza velluti e sete; passamaneria: spazzolino, frangia e cordone in cotone



BUGOLA

rivestimento: 40VI5565 CAT.E mazza velluti e sete; passamaneria: spazzolino, frangia e cordone in cotone

NISSOLIA





NISSOLIA



rivestimento: 41GL6177 CAT.C; fascia sponda e braccioli: 41ES6158 CAT.C mazza Florence; cuscinetti: ART. C11
41ES6146 CAT. C; 41ES6158 CAT. C mazza Florence; ART. 102 41ES6158 CAT. C mazza Florence



SILENA







SILENA

rivestimento: 40VI5586 CAT. F; seduta: 40VI5577 CAT. E mazza velluti e sete; passamaneria: cordone e frangia in cotone;
cuscinetti: ART. C10 40HO5502 CAT. D mazza velluti e sete

POLIGALA





rivestimento: 41PR5727 CAT.F mazza Prince XI; finitura: COL.23 noce scuro

FUMARIA





FUMARIA



rivestimento: 40HO5507 CAT.D mazza velluti e sete; seduta: 41GL6208 CAT.G mazza Florence;
cuscinetti: ART. B92 40HO5507 CAT. D mazza velluti e sete; ART. B94 40HO5507 CAT. D, 40ID5511 CAT. E
mazza velluti e sete; finitura: COL.23 noce scuro





LIGHTS
ACCESSORIES
FINISHES



piantana Caladium ART 272



lampadario Caladium ART 271



lampada Caladium ART 273

FINITURE VETRI



bianco lucido ambra paglierino celeste



nero lucido viola rosso



fumè grigio fumè ambra cristallo trasparente

I paralumi si possono avere nei seguenti colori:
white, black, ivory





piantana Exagon ART 269



lampadario Exagon ART 268



lampada Exagon ART 270

FINITURE VETRI



bianco lucido ambra paglierino celeste



nero lucido viola rosso



fumè grigio fumè ambra cristallo trasparente

I paralumi si possono avere nei seguenti colori:
white, black, ivory





ART 029 - cuscino 40 x 40 con bordino



ART 034 - cuscino 60 x 60 con bordino



ART 046 - cuscino 60 x 60 con spazzolino



ART A45 - cuscino 50 x 50 con fiocchettata



ART A58 - cuscino 50 x 50 con bordino e fiocco di tessuto



ART A71 - cuscino 55 x 55 con spazzolino e frangia ad angolo



ART 048 - cuscino 45 x 45 con frisè



ART 052 - cuscino tondo Ø 47 arricciato



ART 053 - cuscino 50 x 50 con bordino



ART A76 - cuscino 40 x 65 con bordino



ART A81 - cuscino 50 x 50 con bordo plissé



ART B06 - cuscino 35 x 60 con bordino



ART 055 - cuscino 55 x 55 con bordino



ART 058 - cuscino 50 x 50 con spazzolino



ART 102 - cuscino 45 x 45 con bordino



ART B35 - cuscino 50 x 50 con ART 1015



ART B39 - cuscino 45 x 45 con ART 1010



ART B84 - cuscino 55 x 55 con ART 33271



ART B85 - cuscino 50 x 50 con ART 33273



ART B86 - cuscino 45 x 45 con ART 33270



ART B87 - cuscino 35 x 60 con centrale e plissé e ART 33080



ART B94 - cuscino 35 x 60 con bordino bicolore



ART B95 - cuscino 50 x 50 con applicazione centrale e ART 1407



ART B96 - cuscino 45 x 45 con riquadro applicato



ART B88 - cuscino 25 x 40 con fiocco e rosetta



ART B89 - cuscino 35 x 60 con ricamo in qualsiasi colore e bordino



ART B90 - cuscino 35 x 60 con ART 31281



ART B97 - cuscino 45 x 45 con passamaneria 1200



ART B98 - cuscino tondo Ø 47 arricciato con 36015



ART B99 - cuscino 45 x 45 con ART 33096



ART B91 - cuscino 50 x 50 con Swarovski blue e bordino



ART B92 - cuscino tondo Ø 47 arricciato con spazzolino e bottone



ART B93 - cuscino 45 x 45 con bottoni e spazzolino



ART C01 - cuscino 45 x 45 con bordo plissé sui due lati



ART C02 - cuscino 50 x 50 con griffe Swarovski e spazzolino



ART C03 - cuscino 45 x 45 con ART 1404



ART C04 - cuscino 45 x 45 a quadri con ART 33270



ART C05 - cuscino 35 x 55 con applicazione centrale e ART 31249



ART C06 - cuscino 30 x 60 con ART 1012



ART C13 - cuscino Ø 47 arricciato ART 1407



copribracciolo a mantellina con fiocchi ART 114



ART C07 - cuscino 60 x 60 con ART 1407



ART C08 - cuscino tondo Ø 47 con bordo plissé



ART C09 - cuscino 60 x 50 con riquadro e spazzolino



ART C10 - cuscino Ø 47 con arricciatura



ART C11 - cuscino 45 x 45 a quadri con ART 1013



ART C12 - cuscino 45 x 45 con volant e ART 1403

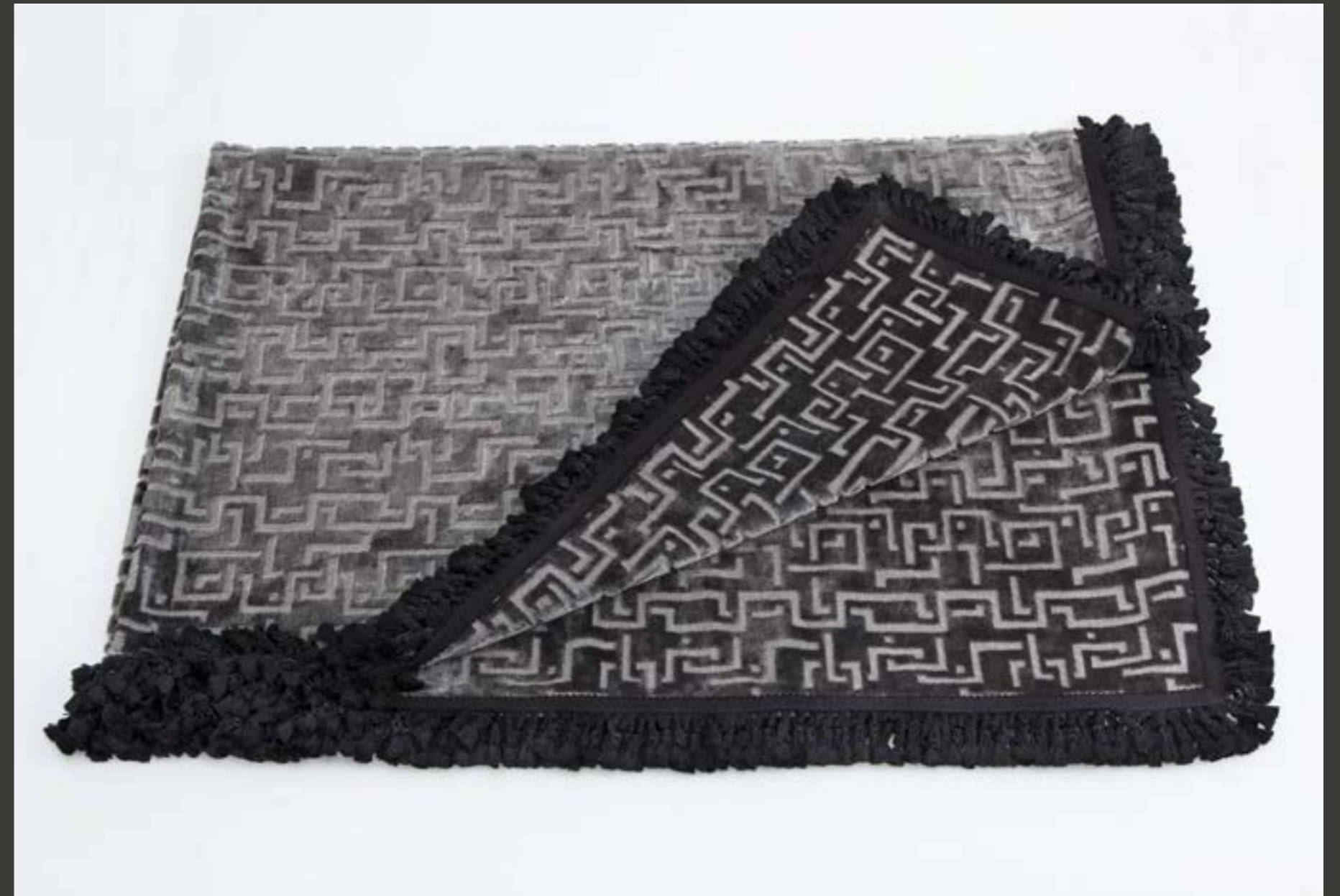

plaid Henry 200 x 240 ART 33025



9010



9020



9045



35476 / 9130



9110



9140



9200



9300



9320



9400



9430



9445



9625



9680



9720



9775



9787



9810



9830



9880

VENDÔME





COL. 9130



35136

VENDÔME



31276



31308



32236



36316



33080



33060

CODE	DÉSIGNATION	LARG. (mm)	Ø (mm)	LONG. (cm)	HAUT. (cm)	PIÈCE (ml)	POIDS (g/uv)	COMPOSITION	DESIGNATION	WIDTH/DIAMETER (inch)	LENGTH (inch)	HEIGHT (inch)	QTY (yd)
31276	Câblé sur pied		8			50	40	40%CV 60%CO	Piping cord	5/16"			54,70 yd
31308	Lézarde	18				50	13	63%CV 37%CO	Gimp	3/4"			54,70 yd
32236	Galon guipure	62				50	50	44%CV 56%CO	Gimped braid	2"1/3			54,70 yd
33060	Effillé à quilles				8	50	100	50%WD 30%WD 20%CO	Beaded cut fringe			3"1/8	54,70 yd
33080	Frangé à quilles				7	50	100	50%WD 35%CV 15%CO	Beaded fringe			2"3/4	54,70 yd
35136	Embrasse guipure	25		90			35	54%CV 46%CO	Gimped cord tie-back		35"7/16		
35181	Gland de clé				12	40	40	43%CV 26%PES 19%WD 12%CO	Key tassel			4"3/4	
35476	Embrasse 2 glands			100	30	630		40%CV 30%CO 20%WD 10%PES	Tassels tie-back		39"3/8	11"3/16	
35481	Embrasse 2 glands			80	18	255		37%CV 30%CO 26%PES 7%WD	Tassels tie-back		31"1/2	6"3/4	
36316	Cartisane		63			15		65%WD 15%CV 20%CO	Rosette	2"1/2			



9000



9010



9020



35294 / 9620



9110



9120



9300



9400



9460



9500



9580



9600



9710



9720



9800



9820



9900

VALMONT



COL. 9620

35294



35295



32620

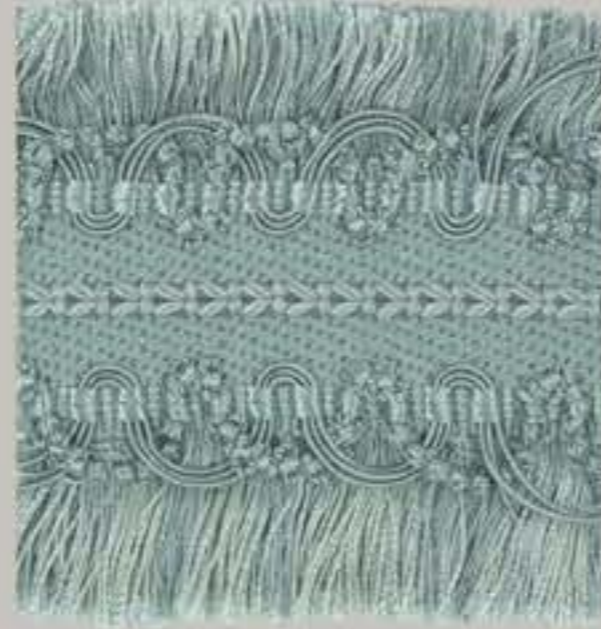

33025

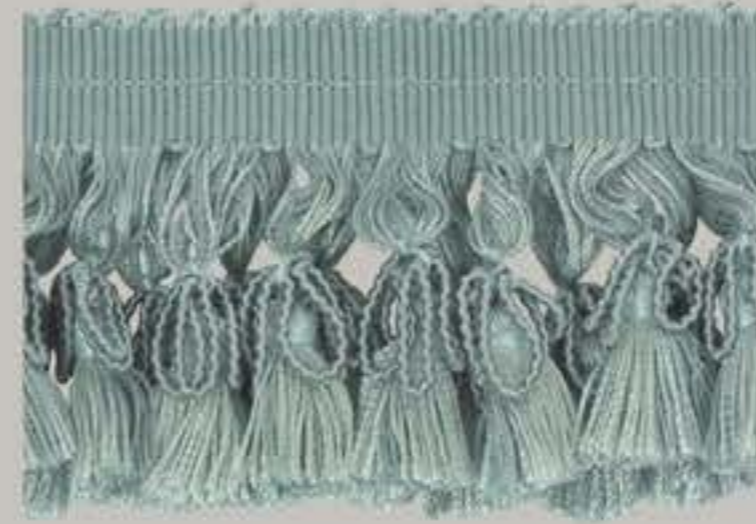

36026 : 120 mm
36027 : 210 mm



COL. 9620

31249



31247



31302



31248



33156

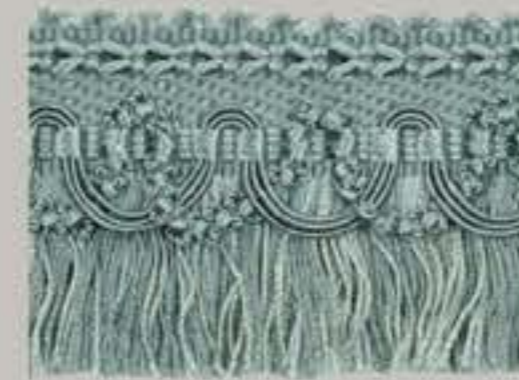

32624

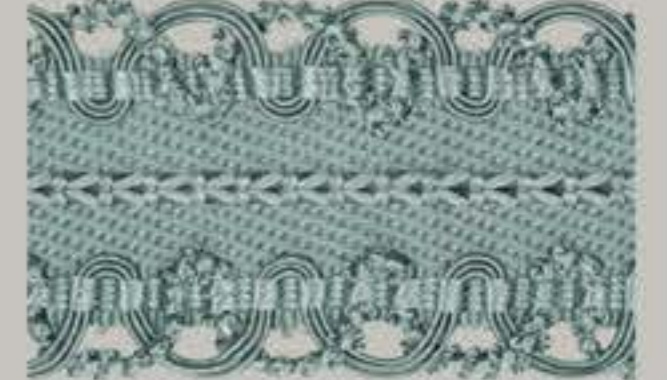

VALMONT

36319



33425



35304



CODE	DÉSIGNATION	LARG. (mm)	Ø (mm)	LONG. (cm)	HAUT. (cm)	PIÈCE (ml)	POIDS (g/uv)	COMPOSITION	DÉSIGNATION	WIDTH/DIAMETER (inch)	LENGTH (inch)	HEIGHT (inch)	QTY (yd)
32620	Galon effilé	90				50	117	62%CV 26%PAN 5%CO 2%PA 5%PES	Braid	3"17/32			54,70 yd
33425	Frangue quilles				10,7	25	148	33%PAN 18%CV 41%WD 8%PES	Beaded fringe			4"7/32	27,40 yd
35294	Embrasse à glands			90	26		633	47%CV 45%CO 8%PAN	Tassel tieback		35"7/16	10"1/4	
35295	Gland de clé				10		34	55%CV 36%PAN 9%CO	Key tassel			3"15/16	
35304	Embrasse galon	53		90			54	63%CV 22%PAN 15%CO	Braid tieback	2"3/32	35"7/16		
36319	Cartisane		50				8	66%CV 18%PAN 16%CO	Rosette	3/16"			

CODE	DÉSIGNATION	LARG. (mm)	Ø (mm)	LONG. (cm)	HAUT. (cm)	PIÈCE (ml)	POIDS (g/uv)	COMPOSITION	DÉSIGNATION	WIDTH/DIAMETER (inch)	LENGTH (inch)	HEIGHT (inch)	QTY (yd)
31247	Câblé sur pied		8			50	31	62%CO 18%CV 11%PES 9%PAN	Piping cord	5/16"			54,70 yd
31248	Câblé sur pied		4			50	9	34%CO 31%PES 24%CV 11%PAN	Piping cord	5/32"			54,70 yd
31249	Câblé		8			50	27	68%CO 20%CV 9%PAN 3%PES	Cord				54,70 yd
31302	Lézarde	11				50	11	60%CV 31%PAN 9%CO	Gimp	7/16"			54,70 yd
32624	Galon guipé	53				50	60	62%CV 26%PAN 10%CO 2%PA	Gimped Braid	2"3/32			54,70 yd
33025	Frangue mèches double				6,5	50	142	51%CV 37%PAN 6%CO 6%PES	Double Tassel fringe			2"9/16	54,70 yd
33156	Effilé				5,1	50	52	62%CV 31%PAN 6%CO 1%PA	Cut fringe			2"	54,70 yd
36026	Frangue torse				12	25	156	45%CO 32%CV 23%PAN	Bullion fringe			4"23/32	27,40 yd
36027	Frangue torse				21	25	266	47%CO 32%CV 21%PAN	Bullion fringe			8"9/32	27,40 yd



9017



9047



35477 / 9900



9100



9123



9275

LES MARQUISES



9310



9600



9700



9760



9820



9890





LES MARQUISES



36081

COL. 9900



3561



36222



33274



33271

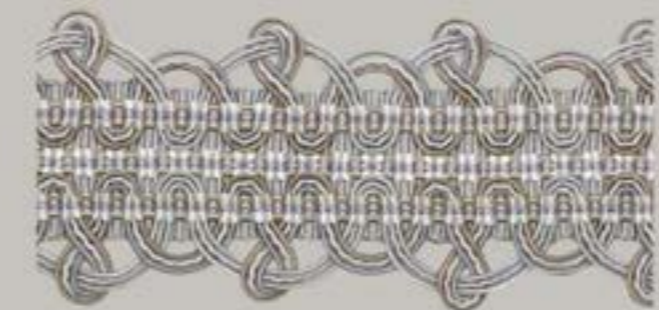

32610



33272



33270



31350



31281



31278



33050



33273

CODE	DÉSIGNATION	LARG. (mm) Width	Ø (mm)	LONG. (cm) Length	HAUT. (cm) Height	PIÈCE (ml)	POIDS (g/uv) Weight	COMPOSITION	DÉSIGNATION	WIDTH/ DIAMETER (inch)	LENGTH (inch)	HEIGHT (inch)
35199	Gland de clé				120	25	41%CV 36%CO 23%WD	Key tassel				4"23/32
35477	Embrasse enjolivée			100	250	635	56%CV 26%CO 18%WD	Tassel tie-back		39"3/8	9"27/32	
35483	Embrasse à glands PM			80	180	265	37%CV 48%CO 15%WD	Tassel tie-back		31"1/2	7"3/32	
35484	Embrasse à glands GM			120	300	850	29%CV 53%CO 18%WD	Tassel tie-back		47"1/4	11"13/16	
35610	Embrasse câblé		30		120	395	70%CO 20%CV 10%WD	Cord tie-back	1"3/16	47"1/4		
36081	8 Miroirs				21	8	52%CV 48%WD	8 Rosettes	13/16"			
36222	Jeu de glands			89	70	20	59%CV 31%CO 10%WD	Chair-tie		35"1/32	2"3/4	

CODE	DÉSIGNATION	LARG. (mm) Width	Ø (mm)	LONG. (cm) Length	HAUT. (cm) Height	PIÈCE (ml)	POIDS (g/uv) Weight	COMPOSITION	DÉSIGNATION	WIDTH/ DIAMETER (inch)	LENGTH (inch)	HEIGHT (inch)	QTY (yd)
31278	Câblé sur pied		5			50	10	51%CO 29%CV 20%PES	Piping cord	3/16"			54,70 yd
31281	Câblé sur pied		10			50	50	57%CO 34%CV 9%PES	Piping cord	13/32"			54,70 yd
31350	Corde à puits	14				50	18	43%CO 32%CV 25%PAN	Braid	5"1/2			54,70 yd
32610	Galon	40				50	20	78%CV 16%CO 6%PAN	Braid	1"9/16			54,70 yd
33050	Frange mousse				4	50	40	100%SE	Moss fringe			1"9/16	54,70 yd
33270	Frange moulinée perles				7	50	90	61%CV 30%CO 9%PES	Beaded bullion fringe			2"3/4	54,70 yd
33271	Frange mèches				7,6	50	100	94%CV 3%CO 3%PES	Tassel fringe			3"	54,70 yd
33272	Frange mèches				6,7	50	65	85%CV 5%CO 10%PES	Tassel fringe			2"5/8	54,70 yd
33273	Frange perles				2,3	50	36	100%CV	Tassel fringe			29/32"	54,70 yd
33274	Frange mèches				3,7	50	40	92%CV 5%CO 3%PES	Tassel fringe			1"15/32	54,70 yd



9020



9080



9110



35301 / 9491



9120



9350



9410



9440



9470



9510



9515



9580



9600



9620



9710



9716



9760



9800



9910



9920

PALAIS ROYAL





35301



35300



35296



35193

PALAIS ROYAL



36015

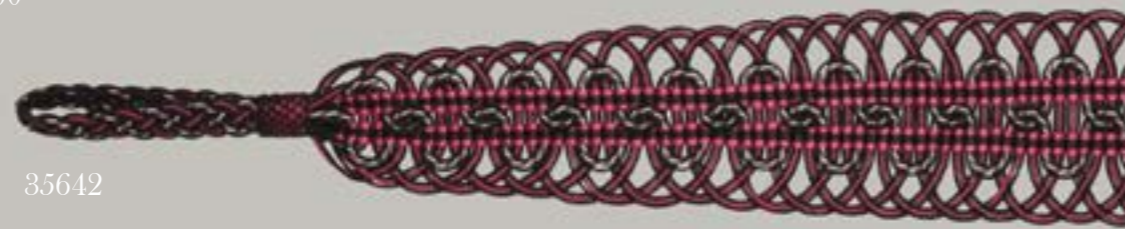

35642

COL. 9491

CODE	DÉSIGNATION	LARG. (mm)	Ø (mm)	LONG. (cm)	HAUT. (cm)	PIÈCE (ml)	POIDS (g/uv)	COMPOSITION	DÉSIGNATION	WIDTH/ DIAMETER (inch)	LENGTH (inch)	HEIGHT (inch)
35193	Gland de clé				13		33	36%CV 21%PAN 26%CO 17%WD	Key tassel			5"1/8
35296	Embrasse 2 glands			100	35		610	35%CV 32%CO 20%PAN 13%WD	Double tassels tieback		39"3/8	13"25/32
35300	Embrasse 1 gland			100	40		375	36%PAN 28%CV 28%CO 8%WD	Tassel tieback		39"3/8	15"3/4
35301	Embrasse 2 glands à perles			100	27		525	30%WD 28%CV 27%CO 15%PAN	Beaded double tassels tieback		39"3/8	10"5/8
35642	Embrasse guipure	90		91			78	46%CO 43%CV 11%PAN	Gimped tieback	3"17/32	35"13/16	
36015	Cartisane		70				15	41%WD 37%CV 17%CO 5%PAN	Rosette	2"3/4		



32150



31081



31332



33096



33098



31241



33097



32151



33022



32630

		(mm) Width	(mm)	(cm) Length	(cm) Height	(ml)	(g/uv) Weight		DIAMETER (inch)	(inch)	(yd)
31081	Lézarde	13				25	11	51%CV 42%CO 7%PA	Gimp	1/2"	27,35 yd
31241	Câblé sur pied		12			25	63	47%CO 31%CV 15%PAN 7%PES	Piping cord	15/32"	27,35 yd
31332	Câblé		12			25	59	50%CO 33%CV 17%PAN	Cord	15/32"	27,35 yd
32150	Galon	25				25	26	45%CV 39%CO 12%PAN 4%PA	Braid	31/32"	27,35 yd
32151	Galon	65				25	76	50%CO 46%CV 4%PA	Braid	2"9/16	27,35 yd
32630	Galon	60				25	28	64%CV 36%PAN	Braid	2"3/8	27,35 yd
33022	Frang moussé				4	25	80	67%CV 19%PAN 11%CO 2%PES 1%PA	Moss fringe		1"9/16 27,35 yd
33096	Frang perles				6	25	113	62%CV 23%CO 8%PES 5%PAN 2%PA	Beaded fringe		2"3/8 27,35 yd
33097	Frang mouliné avec perles				9	25	164	44%CV 31%CO 19%PAN 5%PES 1%PA	Bullion beaded fringe		3"17/32 27,35 yd
33098	Frang perles				4	25	44	58%CV 17%PES 14%CO 7%PAN 4%PA	Beaded fringe		1"9/16 27,35 yd

AIDA



FRANGIA SFILATA 900 cm 20
bordo ART0217 cucito
disponibile in vari colori



ART 1010 col. 1



ART 1010 col. 2



ART 1010 col. 3



ART 1010 col. 4



ART 1010 col. 5



ART 1010 col. 6



ART 1200 col. 1



ART 1201 col. 1



ART 1200 col. 2



ART 1201 col. 2



ART 1200 col. 5



ART 1201 col. 5

CALDE ATMOSFERE



ART 1204 col. 1



ART 1204 col. 2



ART 1204 col. 5



ART 1200 col. 3



ART 1201 col. 3



ART 1200 col. 4



ART 1201 col. 4



ART 1200 col. 6



ART 1201 col. 6



ART 1204 col. 3



ART 1204 col. 4



ART 1204 col. 6



ART 1407 col. 1, 2, 3, 4, 5, 6, 7, 8



ART 1401 col. 1, 2, 3, 4, 5, 6, 7, 8



ART 1402 col. 1, 2, 3, 4, 5, 6, 7, 8



ART 1403 col. 1, 2, 3, 4, 5, 6, 7, 8



ART 1417 col. 1, 2, 3, 4, 5, 6, 7, 8



ART 1418 col. 1, 2, 3, 4, 5, 6, 7, 8



ART 1404 col. 1, 2, 3, 4, 5, 6, 7, 8



ART 1406 col. 8



ART 1406 col. 4



ART 1406 col. 1



ART 1406 col. 5



ART 1406 col. 2



ART 1406 col. 6



ART 1406 col. 3



ART 1406 col. 7

ROSA DEI VENTI



ART. 40290 - 14
(30x16 mm) nickel



ART. 40290 - 32 (30x16 mm)
brushed aluminium



ART. 40290 - 17
(30x16 mm) matt black



ART. 40290 - 19
(30x16 mm) gunmetal



ART. 40291 - 14
(Ø 30 mm) nickel



ART. 40291 - 32 (Ø 30 mm)
brushed aluminium



ART. 40291 - 17
(Ø 30 mm) matt black



ART. 40291 - 19
(Ø 30 mm) gunmetal



ART. 40292 - 14
(Ø 16 mm) nickel



ART. 40292 - 32 (Ø 16 mm)
brushed aluminium



ART. 40292 - 17
(Ø 16 mm) matt black



ART. 40292 - 19
(Ø 16 mm) gunmetal



ART. 40293 - 14
(Ø 22 mm) nickel



ART. 40293 - 32 (Ø 22 mm)
brushed aluminium



ART. 40293 - 17
(Ø 22 mm) matt black

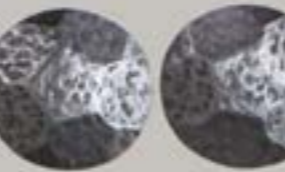

ART. 40293 - 19
(Ø 22 mm) gunmetal



ART. 40294 - 14
(14x14 mm) nickel



ART. 40294 - 32 (14x14 mm)
brushed aluminium



ART. 40294 - 17
(14x14 mm) matt black



ART. 40294 - 19
(14x14 mm) gunmetal



ART. 40295 - 14
(Ø 20 mm) nickel



ART. 40295 - 32 (Ø 20 mm)
brushed aluminium



ART. 40295 - 17
(Ø 20 mm) matt black



ART. 40295 - 19
(Ø 20 mm) gunmetal



ART 40230 (Ø 11 mm)
brushed aluminium



ART 40231 (Ø 11 mm)
nickel



ART 40232 (Ø 11 mm)
silver



ART 40233 (Ø 11 mm)
gunmetal



ART 40234 (Ø 11 mm)
matt black



ART 40235 (Ø 11 mm)
shiny black



ART 40236 (Ø 11 mm)
carbon



ART 40237 (Ø 11 mm)
rust



ART 40238 (Ø 11 mm)
cream



ART 40239 (Ø 11 mm)
antique nickel



ART 40240 (Ø 11 mm)
antique brass



ART 40241 (Ø 11 mm)
antique copper



Col. 21 noce medio

Col. 22 noce chiaro

Col. 23 noce scuro

Col. 24 foglia argento

Col. 25 foglia old silver



Col. 26 foglia oro

Col. 27 white e gold

Col. 28 bianco

Col. 29 bianco antico

Col. 30 scrape white



Col. 34 moka

Col. 35 grigio fiume

Col. 36 bianco lucido

Col. 37 nero lucido

Col. 38 crema tortora



Col. 39 cenere

Col. 40 sabbia

Col. 41 radica scuro

Col. 42 cerusè seppia

Col. 43 foglia oro patinato bianco



Col. 44 bianco argento

Col. 45 foglia argento spazzolata a mano

Col. 46 foglia oro spazzolata a mano

Col. 47 crema

NB. Le finiture sopra riportate non rispecchiano fedelmente i colori reali



TECHNICAL DRAWINGS

ADENIA

PAGINA 16

VERSIONI: poltrona, 2 posti ,2 posti e mezzo, 3 posti. STRUTTURA: legno e suoi derivati, cinghie elastiche incrociate ad alta resistenza. IMBOTTITURA: in poliuretano espanso a quote e qualità differenziate, fibre poliestere. Su richiesta, è possibile personalizzare l'imbottitura con relativi costi aggiuntivi. CARATTERISTICHE: cuscineti con passamaneria e imbottitura in piuma di serie; copribraccioli con bordino e fiocchi di serie; struttura e seduta con bordino; piedi a vista con ruote anteriori e bicchiere posteriore in ottone, la finitura della parte in legno è disponibile nei colori previsti a catalogo.

VERSIONS: armchair, 2 seater sofa, 2 ½ seater sofa and 3 seater sofa. STRUCTURE: in wood and by-products, high resistant strength woven elastic belts. PADDING: expanded polyurethane of differentiated densities and qualities, polyester fibre. On request is possible choose the padding (additional cost). CHARACTERISTICS: goose feather pillows with trimmings included; armcover included; edge with border; visible legs colors provided in the catalog.

ВАРИАНТЫ: кресло, диван 2-х, 2 ½, 3-х местный. СТРУКТУРА: дерево и его производные, перекрещенные эластичные ремни высокой прочности. НАБИВКА: по умолчанию полиуретан средней жесткости (gomma), полистероловые волокна. По запросу можно изменить тип наполнения подушек сидения (за дополнительную плату). ХАРАКТЕРИСТИКИ: по умолчанию декоративные подушки из пуха с басонными изделиями; накладки на подлокотники с отделкой «bordino» и кисточками; отделка подушек сидения и каркаса «bordino»; видимые латунные передние ножки с колесами, задние фиксированные; окраска деревянных элементов в серийных отделах.

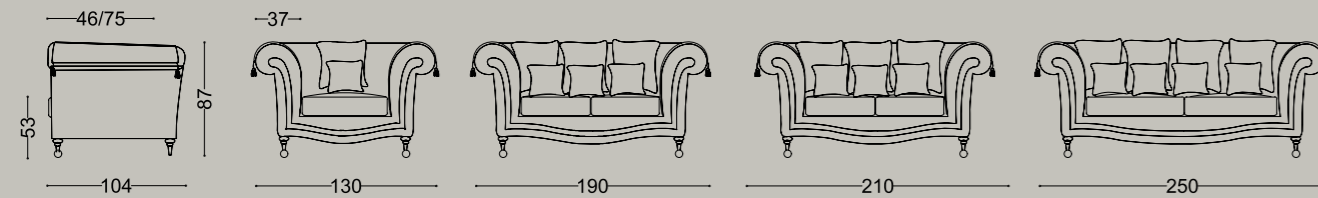

AGAVE

PAGINA 70

VERSIONI: pouf, poltrona e divano 2 posti. STRUTTURA: legno di faggio, cinghie elastiche incrociate ad alta resistenza. IMBOTTITURA: in poliuretano espanso a quote e qualità differenziate, fibre poliestere. Su richiesta, è possibile personalizzare l'imbottitura con relativi costi aggiuntivi. CARATTERISTICHE: seduta con bordino; struttura con trinetta; la finitura è disponibile nei colori previsti a catalogo.

VERSIONS: pouf, armchair and 2 seater sofa. STRUCTURE: in wood and by-products, high resistant strength woven elastic belts. PADDING: expanded polyurethane of differentiated densities and qualities, polyester fibre. On request is possible choose the padding (additional cost). CHARACTERISTICS: wood finishing is available in different colors in the catalog.

ВАРИАНТЫ: пуф, кресло, диван 2-х местный. СТРУКТУРА: дерево бук, перекрещенные эластичные ремни высокой прочности. НАБИВКА: по умолчанию полиуретан средней жесткости (gomma), полистероловые волокна. По запросу можно изменить тип наполнения подушек сидения (за дополнительную плату). ХАРАКТЕРИСТИКИ: по умолчанию отделка подушек сидения «bordino»; отделка каркаса «trinetta»; отделка в цветах, как в каталоге.

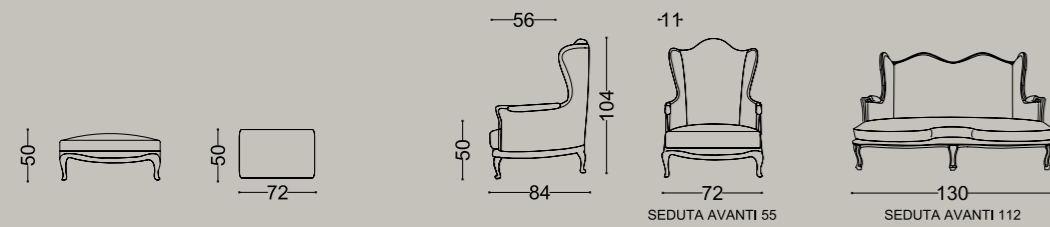

AMARANTO

PAGINA 106

VERSIONI: poltrona, 2 posti e 3 posti. STRUTTURA: legno e suoi derivati, cinghie elastiche incrociate ad alta resistenza. IMBOTTITURA: in poliuretano espanso a quote e qualità differenziate, fibre poliestere. Su richiesta, è possibile personalizzare l'imbottitura. CARATTERISTICHE: cuscineti in piuma di serie; seduta con bordino; struttura con cordone disponibile nei colori previsti a catalogo; base in legno nelle finiture disponibili a catalogo.

VERSIONS: armchair, 2 seater, 3 seater sofa. STRUCTURE: in wood and by-products, high resistant strength woven elastic belts. PADDING: expanded polyurethane of differentiated densities and qualities, polyester fibre. On request is possible choose the padding (additional cost). CHARACTERISTICS: goose feather pillows included; wood finishing is available in different colors in the catalog.

ВАРИАНТЫ: кресло, диван 2-х, 3-х местный. СТРУКТУРА: дерево и его производные, перекрещенные эластичные ремни высокой прочности. НАБИВКА: по умолчанию полиуретан средней жесткости (gomma), полистероловые волокна. По запросу можно изменить тип наполнения подушек сидения (за дополнительную плату). ХАРАКТЕРИСТИКИ: по умолчанию декоративные подушки из пуха с басонными изделиями; отделка подушек сидения «bordino»; каркаса «cordone» как в каталоге; окраска деревянных элементов каркаса в серийных отделах.

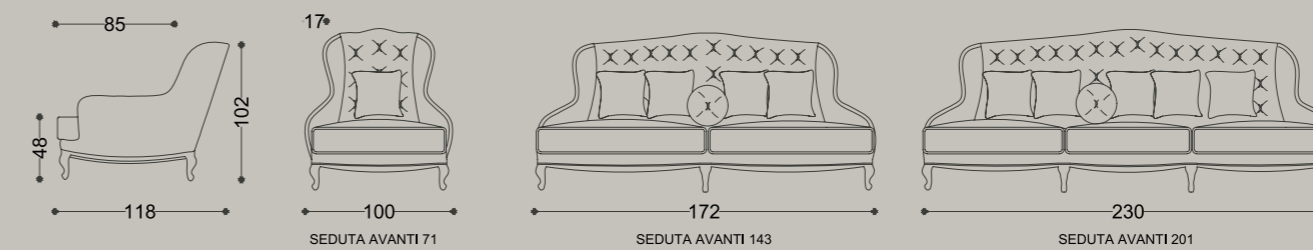

ANEMONE

PAGINA 100

VERSIONI: poltrona, 2 posti, 2 posti e mezzo, 3 posti. STRUTTURA: legno e suoi derivati, cinghie elastiche incrociate ad alta resistenza. IMBOTTITURA: in poliuretano espanso a quote e qualità differenziate, fibre poliestere. Su richiesta, è possibile personalizzare l'imbottitura. CARATTERISTICHE: cuscineti optional; seduta e struttura con bordino; piedi a vista, la finitura è disponibile nei colori previsti a catalogo.

VERSIONS: armchair, 2 seater sofa, 2 ½ seater, 3 seater sofa. STRUCTURE: in wood and by-products, high resistant strength woven elastic belts. PADDING: expanded polyurethane of differentiated densities and qualities, polyester fibre. On request is possible choose the padding (additional cost). CHARACTERISTICS: pillows optional; edge with border; visible legs, colors provided in the catalog.

ВАРИАНТЫ: кресло, диван 2-х, 2 ½, 3-х местный. СТРУКТУРА: дерево и его производные, перекрещенные эластичные ремни высокой прочности. НАБИВКА: по умолчанию полиуретан средней жесткости (gomma), полистероловые волокна. По запросу можно изменить тип наполнения подушек сидения (за дополнительную плату). ХАРАКТЕРИСТИКИ: подушки в стоимость не входят; подушки сидения и каркас с отделкой «bordino»; видимые ножки в серийных отделах.

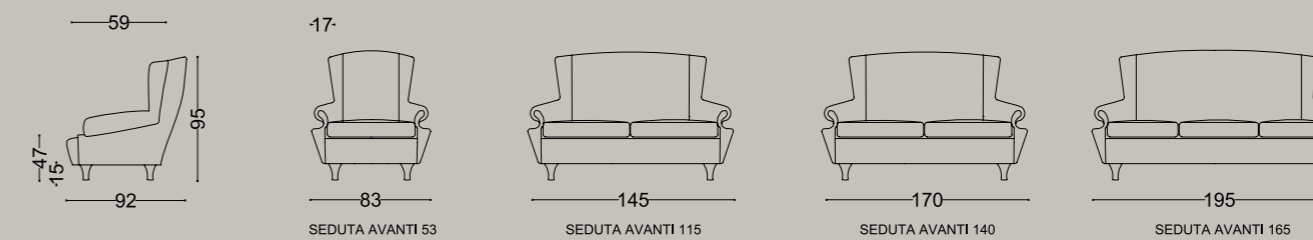

BUGOLA

PAGINA 124

VERSIONI: 2 posti, 3 posti e 3 posti e mezzo. STRUTTURA: legno e suoi derivati, cinghie elastiche incrociate ad alta resistenza. IMBOTTITURA: in poliuretano espanso a quote e qualità differenziate, fibre poliestere. Su richiesta, è possibile personalizzare l'imbottitura. CARATTERISTICHE: cuscinetti in piuma di serie; seduta con spazzolino; struttura con bordino; frangia madera e cordone alla base.

VERSIONS: 2 seater sofa, 3 seater, 3 1/2 seater sofa. STRUCTURE: in wood and by-products, high resistant strength woven elastic belts. PADDING: expanded polyurethane of differentiated densities and qualities, polyester fibre. On request is possible choose the padding (additional cost). CHARACTERISTICS: goose feather pillows included.

ВАРИАНТЫ: диван 2-х, 3 1/2, 3-х местный. СТРУКТУРА: дерево и его производные, перекрещенные эластичные ремни высокой прочности. НАБИВКА: по умолчанию полиуретан средней жесткости (gomma), полистероловые волокна. По запросу можно изменить тип наполнения подушек сидения (за дополнительную плату). ХАРАКТЕРИСТИКИ: по умолчанию декоративные подушки из пуха; отделка подушек сидения «spazzolino», каркаса «bordino»; декоративная бахромчатая юбка «frangia» с отделкой «cordone».

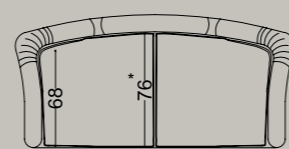
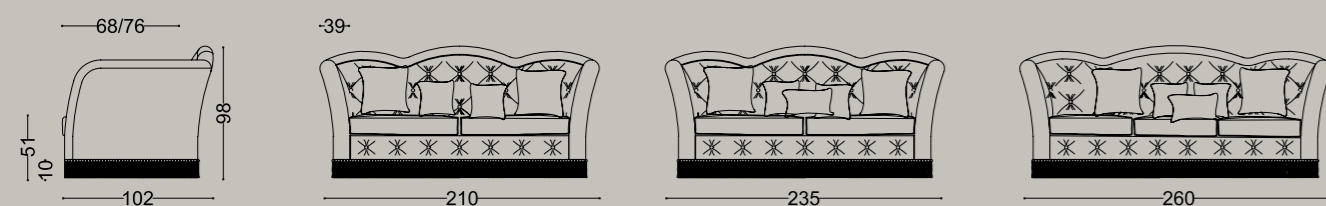

* MISURA SENZA CUSCINETTI

CHANTAL

PAGINA 22

VERSIONI: poltrona, 2 posti, 2 posti e mezzo, 3 posti, 3 posti e mezzo. STRUTTURA: legno e suoi derivati, cinghie elastiche incrociate ad alta resistenza. IMBOTTITURA: in poliuretano espanso a quote e qualità differenziate, fibre poliestere. Su richiesta, è possibile personalizzare l'imbottitura con relativi costi aggiuntivi. CARATTERISTICHE: cuscinetti optional; seduta e struttura con bordino; piedi a vista, la finitura è disponibile nei colori previsti a catalogo.

VERSIONS: armchair, 2 seater, 2 1/2 seater, 3 seater sofa and 3 1/2 seater sofa. STRUCTURE: in wood and by-products, high resistant strength woven elastic belts. PADDING: expanded polyurethane of differentiated densities and qualities, polyester fibre. On request is possible choose the padding (additional cost). CHARACTERISTICS: goose feather pillows optional; edge with border; visible legs colors provided in the catalog.

ВАРИАНТЫ: кресло, диван 2-х, 2 1/2, 3-х, 3 1/2 местный. СТРУКТУРА: дерево и его производные, перекрещенные эластичные ремни высокой прочности. НАБИВКА: по умолчанию полиуретан средней жесткости (gomma), полистероловые волокна. По запросу можно изменить тип наполнения подушек сидения (за дополнительную плату). ХАРАКТЕРИСТИКИ: подушки в стоимость не входят; отделка подушек сидения и каркаса «bordino»; видимые ножки в серийных отделах.

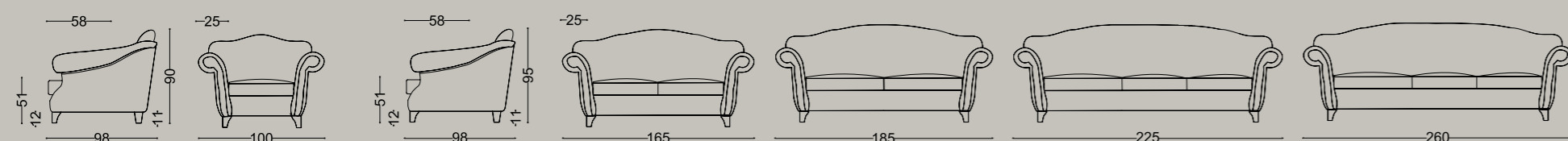

CLEMATIDE

PAGINA 8

VERSIONI: 2 posti, 3 posti, 3 posti e mezzo e 3 posti curvo con un braccio. STRUTTURA: legno e suoi derivati, cinghie elastiche incrociate ad alta resistenza. IMBOTTITURA: in poliuretano espanso a quote differenziate, fibre poliestere. Su richiesta, è possibile personalizzare l'imbottitura con relativi costi aggiuntivi. CARATTERISTICHE: cuscinetti in piuma di serie; seduta con bordino; cordolo schienale con cordone.

VERSIONS: 2 seater sofa, 3 seater sofa, 3 1/2 seater sofa curved with 1 arm. STRUCTURE: in wood and by-products, high resistant strength woven elastic belts. PADDING: expanded polyurethane of differentiated densities and qualities, polyester fibre. On request is possible choose the padding (additional cost). CHARACTERISTICS: edge with border; goose feather pillows included.

ВАРИАНТЫ: диван 2-х, 3-х, 3 1/2, 3-х местный закругленный. СТРУКТУРА: дерево и его производные, перекрещенные эластичные ремни высокой прочности. НАБИВКА: по умолчанию полиуретан средней жесткости (gomma), полистероловые волокна. По запросу можно изменить тип наполнения подушек сидения (за дополнительную плату). ХАРАКТЕРИСТИКИ: по умолчанию декоративные подушки из пуха; отделка подушек сидения «bordino»; отделка спинки «cordone».

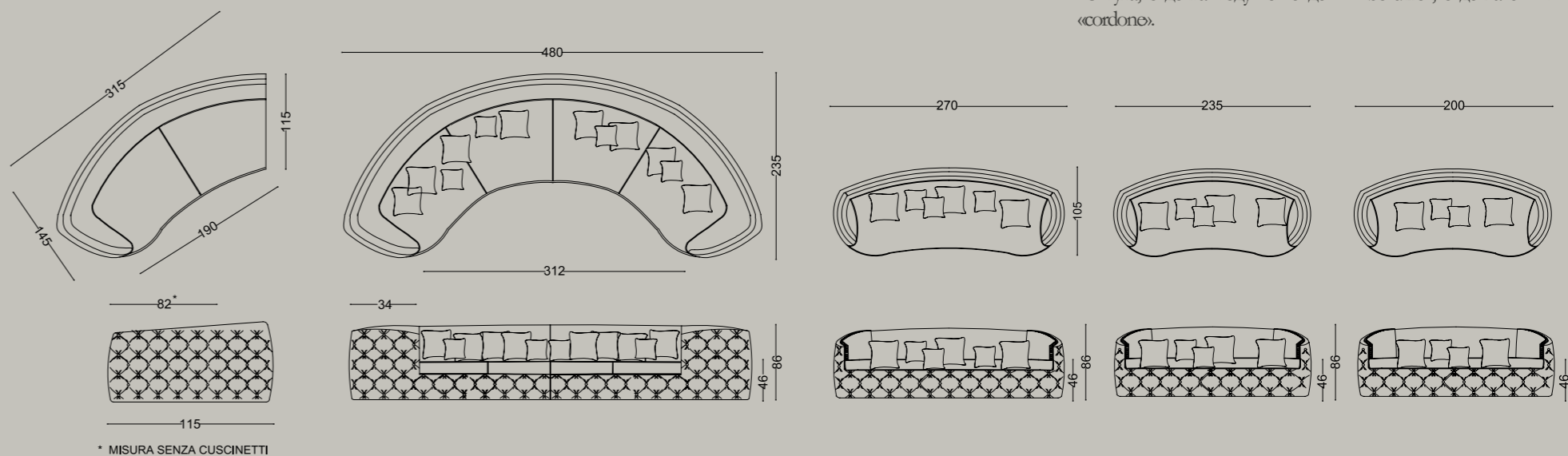

FALASCO

PAGINA 15

VERSIONI: poltrona, 2 posti e mezzo, 3 posti, 3 posti e mezzo. STRUTTURA: legno e suoi derivati, cinghie elastiche incrociate ad alta resistenza. IMBOTTITURA: in poliuretano espanso a quote e qualità differenziate, fibre poliestere. Su richiesta, è possibile personalizzare l'imbottitura con relativi costi aggiuntivi. CARATTERISTICHE: profili con bordino; piedi a vista, la finitura è disponibile nei colori previsti a catalogo.

VERSIONS: armchair, 2 1/2 seater sofa, 3 seater sofa and 3 1/2 seater sofa. STRUCTURE: in wood and by-products, high resistant strength woven elastic belts. PADDING: expanded polyurethane of differentiated densities and qualities, polyester fibre. On request is possible choose the padding (additional cost). CHARACTERISTICS: edge with border; visible legs colors provided in the catalog.

ВАРИАНТЫ: кресло, диван 2 1/2, 3-х, 3 1/2 местный. СТРУКТУРА: дерево и его производные, перекрещенные эластичные ремни высокой прочности. НАБИВКА: по умолчанию полиуретан средней жесткости (gomma), полистероловые волокна. По запросу можно изменить тип наполнения подушек сидения (за дополнительную плату). ХАРАКТЕРИСТИКИ: по умолчанию отделка подушек сидения и каркаса «bordino»; видимые ножки в серийных отделах.

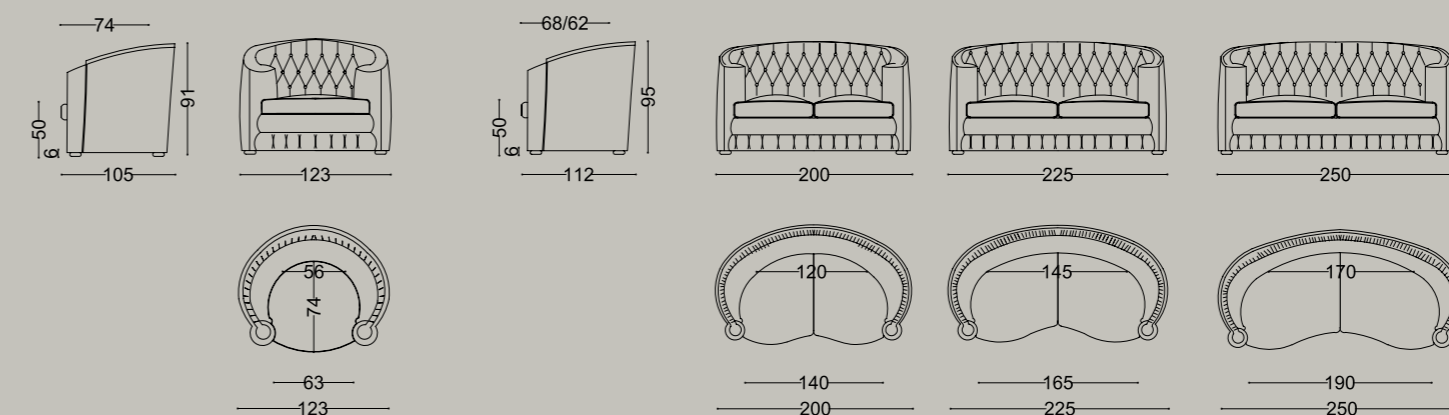

FUMARIA

PAGINA 148

VERSIONI: 2 posti, 3 posti e 3 posti e mezzo. STRUTTURA: legno e suoi derivati, cinghie elastiche incrociate ad alta resistenza. IMBOTTITURA: in poliuretano espanso a quote e qualità differenziate, fibre poliestere. Su richiesta, è possibile personalizzare l'imbottitura. CARATTERISTICHE: cuscinetti di serie; seduta e struttura con bordino; piedi a vista, la finitura e' disponibile nei colori previsti a catalogo.

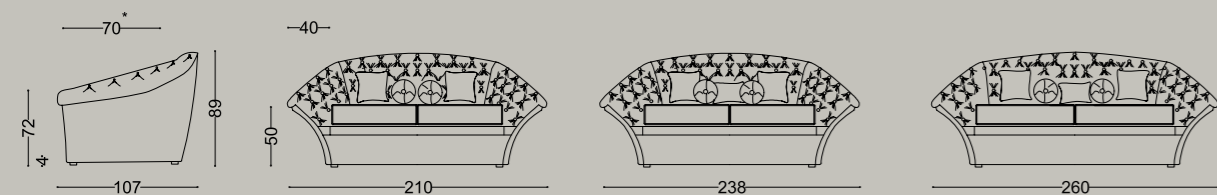

* MISURA SENZA CUSCINETTI

VERSIONS: 2 seater sofa, 3 seater sofa and 3 1/2 seater sofa. STRUCTURE: in wood and by-products, high resistant strength woven elastic belts. PADDING: expanded polyurethane of differentiated densities and qualities, polyester fibre. On request is possible choose the padding (additional cost). CHARACTERISTICS: goose feather pillows included; edge with border; visible legs, colors provided in the catalog.

ВАРИАНТЫ: диван 2-х, 3 1/2, 3-х местный. СТРУКТУРА: дерево и его производные, перекрещенные эластичные ремни высокой прочности. НАБИВКА: по умолчанию полиуретан средней жесткости (gomma), полистероловые волокна. По запросу можно изменить тип наполнения подушек сидения (за дополнительную плату). ХАРАКТЕРИСТИКИ: по умолчанию серийные подушки; отделка подушек сидения и каркаса «bordino»; видимые ножки в серийных отделаках.



HENRY

PAGINA 58

VERSIONI: poltrona, 2 posti, 2 posti e mezzo, 3 posti e 3 posti e mezzo. STRUTTURA: legno e suoi derivati, cinghie elastiche incrociate ad alta resistenza. IMBOTTITURA: in poliuretano espanso a quote e qualità differenziate, fibre poliestere. CARATTERISTICHE: cuscinetti optional; seduta fissa; struttura con bordino; piedi a vista rivestiti.

VERSIONS: armchair, 2 seater, 2 1/2 seater, 3 seater sofa and 3 1/2 seater sofa. STRUCTURE: in wood and by-products, high resistant strength woven elastic belts. PADDING: expanded polyurethane of differentiated densities and qualities, polyester fibre. CHARACTERISTICS: goose feather pillows optional; edge with border.

ВАРИАНТЫ: кресло, диван 2-х, 2 1/2, 3-х, 3 1/2 местный. СТРУКТУРА: дерево и его производные, перекрещенные эластичные ремни высокой прочности. НАБИВКА: по умолчанию полиуретан средней жесткости (gomma), полистероловые волокна. ХАРАКТЕРИСТИКИ: подушки в стоимость не входят; по умолчанию несъемная подушка сидения; отделка каркаса «bordino»; видимые ножки обтянуты тканью.

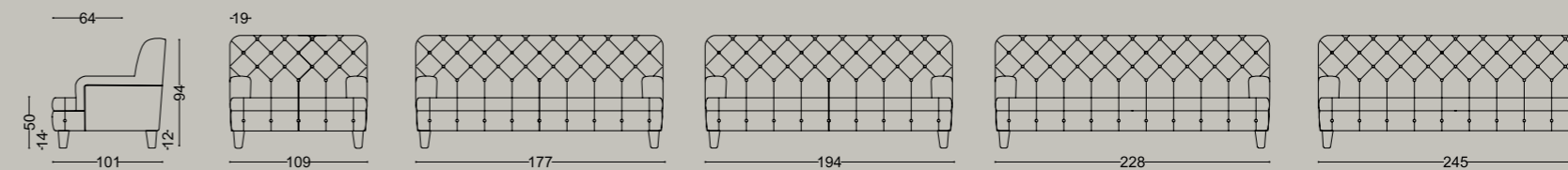

GALLIO

PAGINA 44

VERSIONI: poltrona, 2 posti, 2 posti e mezzo, 3 posti e 3 posti e mezzo. Il divano 2 posti, 2 posti e mezzo, 3 posti e 3 posti e mezzo e' disponibile nella versione letto con rete elettrosaldata e materasso in fibra poliuretana h 13 cm. STRUTTURA: legno e suoi derivati, cinghie elastiche incrociate ad alta resistenza. IMBOTTITURA: in poliuretano espanso a quote e qualità differenziate, fibre poliestere. Su richiesta, è possibile personalizzare l'imbottitura con relativi costi aggiuntivi. CARATTERISTICHE: cuscinetti di serie; frangia sfilata in tinta al tessuto, con applicazione dell' art.33097 in seta facente parte della collezione Palais Royal disponibile nei colori previsti a catalogo ; seduta e struttura con cordone. Disponibile anche con balza.

VERSIONS: armchair, 2 seater, 2 1/2 seater, 3 seater sofa and 3 1/2 seater sofa. The 2 seater, 2 1/2 seater, 3 seater and 3 1/2 seater sofa is available in bed version with electrowelded frame and polyurethane mattress of 13 cm. STRUCTURE: in wood and by-products, high resistant strength woven elastic belts. PADDING: expanded polyurethane of differentiated densities and qualities, polyester fibre. On request is possible choose the padding (additional cost). CHARACTERISTICS: goose feather pillows included; fringe as photo with art.33097 Palais Royal collection in the colors provided in the catalog; edge with cordon rope. Available with volant.

ВАРИАНТЫ: кресло, диван 2-х, 2 1/2, 3-х, 3 1/2 местный. Диваны 2-х, 2 1/2, 3-х, 3 1/2 местные могут быть укомплектованы раскладным механизмом с металлической пружинной полиуретановым матрасом 13 см. СТРУКТУРА: дерево и его производные, перекрещенные эластичные ремни высокой прочности. НАБИВКА: по умолчанию полиуретан средней жесткости (gomma), полистероловые волокна. По запросу можно изменить тип наполнения подушек сидения (за дополнительную плату). ХАРАКТЕРИСТИКИ: по умолчанию серийные подушки; декоративная гобка «frangia sfilata» в цвет ткани с басонными шелковыми отделками art.33097 из коллекции Palais Royal в цветах, как в каталоге; подушки сидения и каркаса с отделкой «cordone»; возможна также декоративная гобка.

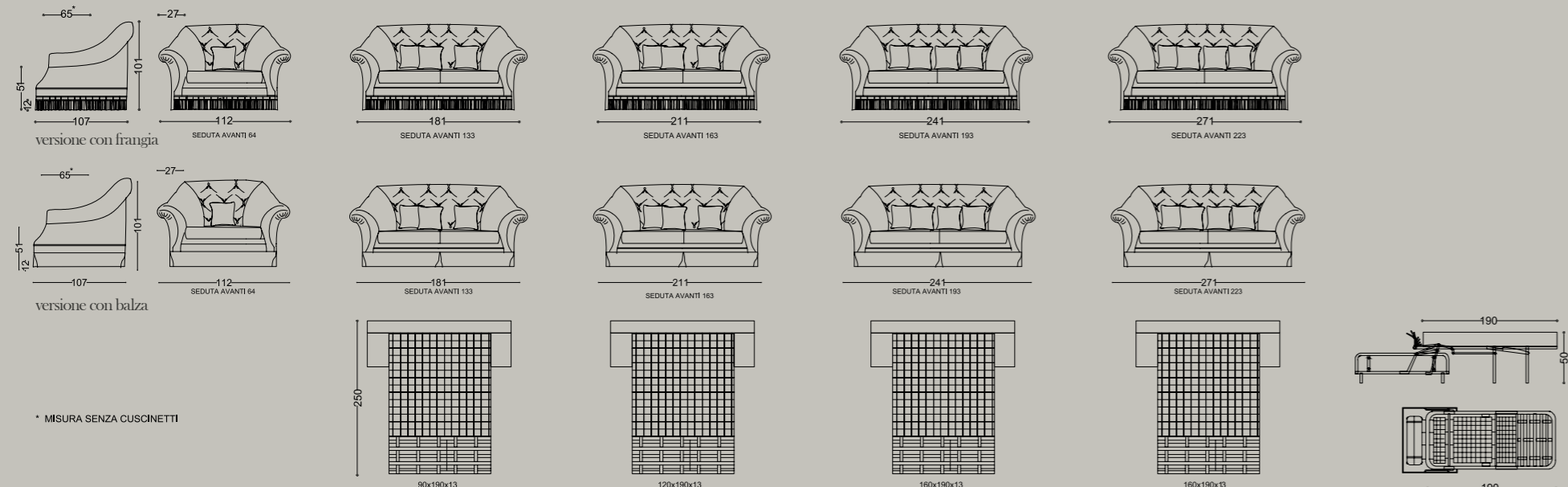

* MISURA SENZA CUSCINETTI

INULA

PAGINA 37

VERSIONI: pouf, poltrona, 2 posti. STRUTTURA: legno e suoi derivati, cinghie elastiche incrociate ad alta resistenza. IMBOTTITURA: in poliuretano espanso a quote differenziate, fibre poliestere. CARATTERISTICHE: poltrona e 2 posti con balza, seduta fissa con bordino; pouf con piedi a vista con ruote in ottone, la finitura della parte in legno e' disponibile nei colori previsti a catalogo.

VERSIONS: pouf, armchair and 2 seater sofa. STRUCTURE: in wood and by-products, high resistant strength woven elastic belts. PADDING: expanded polyurethane of differentiated densities and qualities, polyester fibre. CHARACTERISTICS: armchair and 2 seater with volant; pouf with visible legs colors provided in the catalog.

ВАРИАНТЫ: пуф, кресло, диван 2-х местный. СТРУКТУРА: дерево и его производные, перекрещенные эластичные ремни высокой прочности. НАБИВКА: по умолчанию полиуретан средней жесткости (gomma), полистероловые волокна. ХАРАКТЕРИСТИКИ: у кресла и 2-х местного дивана по умолчанию декоративная гобка, несъемная подушка сидения, отделка «bordino»; у пуфа видимые латунные ножки с колесами, окраска деревянных элементов в серийных отделаках.

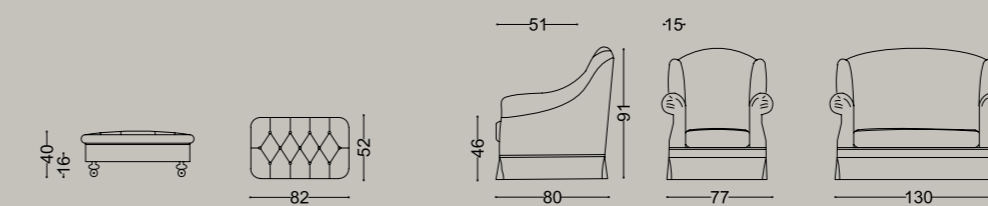

IXORA

PAGINA 98

VERSIONI: poltrona, 2 posti, 3 posti. **STRUTTURA:** legno e suoi derivati, cinghie elastiche incrociate ad alta resistenza. **IMBOTTITURA:** in poliuretano espanso a quote e qualità differenziate, fibre poliestere. Su richiesta, e' possibile personalizzare l'imbottitura con eventuali costi aggiuntivi. **CARATTERISTICHE:** seduta e braccioli con cordone nei colori previsti a catalogo; con frangia madera h20.

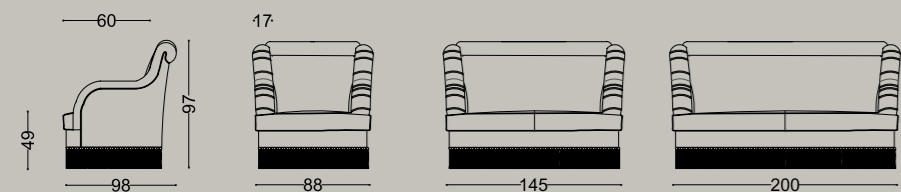

VERSIONS: armchair, 2 seater sofa and 3 seater sofa. **STRUCTURE:** in wood and by-products, high resistant strength woven elastic belts. **PADDING:** expanded polyurethane of differentiated densities and qualities, polyester fibre. On request is possible choose the padding (additional cost). **CHARACTERISTICS:** edge with cordon.

ВАРИАНТЫ: кресло, диван 2-х, 3-х местный. **СТРУКТУРА:** дерево и его производные, перекрещенные эластичные ремни высокой прочности. **НАБИВКА:** по умолчанию полиуретан средней жесткости (gomma), полистероловые волокна. По запросу можно изменить тип наполнения подушек сидения (за дополнительную плату). **ХАРАКТЕРИСТИКИ:** подушка сидения и подлокотники с отделкой «cordone».

KELLY

PAGINA 112

VERSIONI: poltrona, 2 posti, 2 posti e mezzo e 3 posti. **STRUTTURA:** legno e suoi derivati, cinghie elastiche incrociate ad alta resistenza. **IMBOTTITURA:** in poliuretano espanso a quote e qualità differenziate, fibre poliestere. Su richiesta, è possibile personalizzare l'imbottitura in piuma, con passamaneria art.1406 disponibile nei colori previsti a catalogo; seduta con spazzolino; struttura con bordino; piedi a vista con ruote anteriori in ottone, la finitura della parte in legno è disponibile nei colori previsti a catalogo.

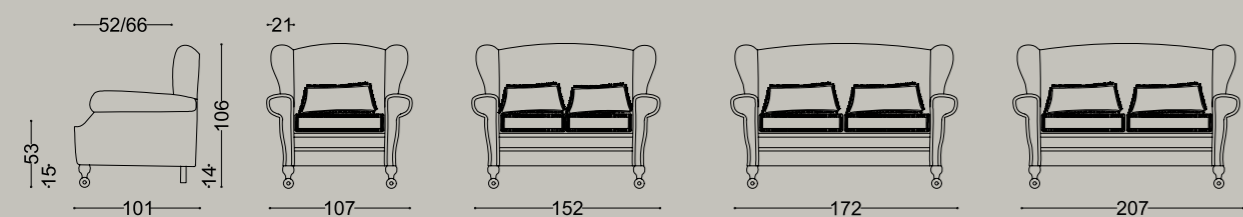

VERSIONS: armchair, 2 seater sofa, 2 1/2 seater, 3 seater sofa. **STRUCTURE:** in wood and by-products, high resistant strength woven elastic belts. **PADDING:** expanded polyurethane of differentiated densities and qualities, polyester fibre. On request is possible choose the padding (additional cost). **CHARACTERISTICS:** visible legs, colors provided in the catalog.

ВАРИАНТЫ: кресло, диван 2-х, 2 1/2, 3-х местный. **СТРУКТУРА:** дерево и его производные, перекрещенные эластичные ремни высокой прочности. **НАБИВКА:** по умолчанию полиуретан средней жесткости (gomma), полистероловые волокна. По запросу можно изменить тип наполнения подушек сидения (за дополнительную плату). **ХАРАКТЕРИСТИКИ:** по умолчанию приспиченные декоративные подушки из пуха с басонными изделиями арт.1406 из коллекции Rosa dei Venti в цветах, как в каталоге; отделка подушек сидения «spazzolino», каркаса «bordino»; видимые ножки, передние латунные ножки с колесами; окраска деревянных элементов в серийных отделаках.

LIMARIA

PAGINA 64

VERSIONI: poltrona, 2 posti, 2 posti e mezzo, 3 posti, 3 posti e mezzo e 4 posti. Il divano 2 posti, 2 posti e mezzo, 3 posti, 3 posti e mezzo e 4 posti è disponibile nella versione letto con rete elettrosaldata e materasso in fibra poliuretana h 13 cm. **STRUTTURA:** legno e suoi derivati, cinghie elastiche incrociate ad alta resistenza. **IMBOTTITURA:** in poliuretano espanso a quote e qualità differenziate, fibre poliestere. Su richiesta, è possibile personalizzare l'imbottitura con relativi costi aggiuntivi. **CARATTERISTICHE:** cuscineti optional; seduta e struttura con bordino; con balza; il ricamo sullo schienale e interno bracci è disponibile in qualsiasi colore.

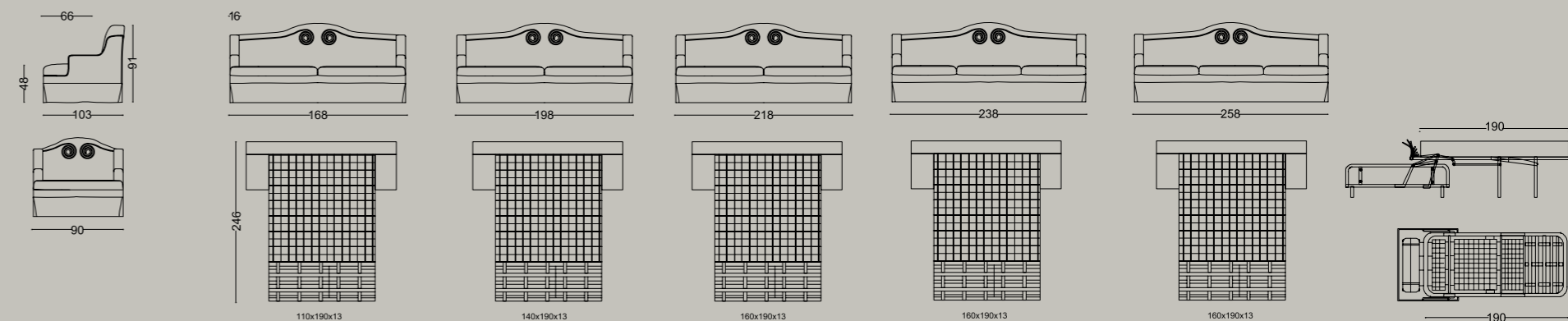

VERSIONS: armchair, 2 seater, 2 1/2 seater, 3 seater sofa, 3 1/2 seater sofa and 4 seater sofa. The 2 seater, 2 1/2 seater, 3 seater sofa, 3 1/2 seater sofa and 4 seater sofa is available in bed version with electrowelded frame and polyurethane mattress of 13 cm. **STRUCTURE:** in wood and by-products, high resistant strength woven elastic belts. **PADDING:** expanded polyurethane of differentiated densities and qualities, polyester fibre. On request is possible choose the padding (additional cost). **CHARACTERISTICS:** goose feather pillows optional; edge with border; with volant; the embroidery is available in all colors.

ВАРИАНТЫ: кресло, диван 2-х, 2 1/2, 3-х, 3 1/2, 4-х местный. Диваны 2-х, 2 1/2, 3-х, 3 1/2, 4-х местные могут быть укомплектованы раскладным механизмом с металлической решеткой и полиуретановым матрасом 13 см. **СТРУКТУРА:** дерево и его производные, перекрещенные эластичные ремни высокой прочности. **НАБИВКА:** по умолчанию полиуретан средней жесткости (gomma), полистероловые волокна. По запросу можно изменить тип наполнения подушек сидения (за дополнительную плату). **ХАРАКТЕРИСТИКИ:** подушки в стоймость не входят; по умолчанию отделка подушек сидения и каркаса «bordino»; декоративные тобки; вышивка на спинке и внутренней части подлокотников возможна в любом цвете.

MUSCARI

PAGINA 92

VERSIONI: 3 posti, 3 posti e mezzo. **STRUTTURA:** legno e suoi derivati, cinghie elastiche incrociate ad alta resistenza. **IMBOTTITURA:** in poliuretano espanso a quote e qualità differenziate, fibre poliestere. Su richiesta, è possibile personalizzare l'imbottitura con relativi costi aggiuntivi. **CARATTERISTICHE:** cuscineti optional; seduta e struttura con bordino; piedi a vista, la finitura è disponibile nei colori previsti a catalogo.

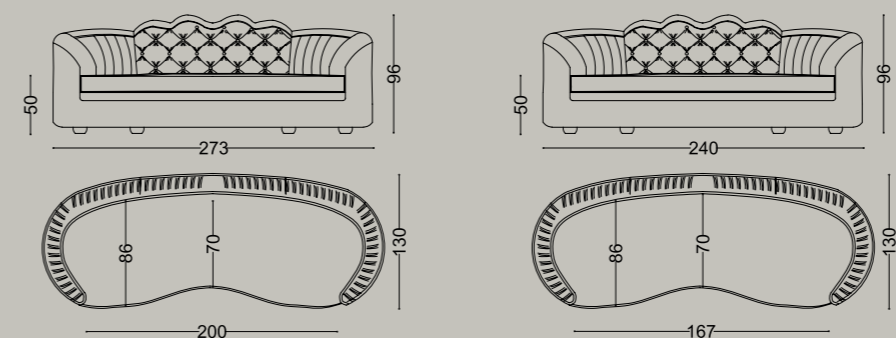

VERSIONS: 3 seater sofa and 3 1/2 seater sofa. **STRUCTURE:** in wood and by-products, high resistant strength woven elastic belts. **PADDING:** expanded polyurethane of differentiated densities and qualities, polyester fibre. On request is possible choose the padding (additional cost). **CHARACTERISTICS:** pillows optional; edge with border; visible legs, colors provided in the catalog.

ВАРИАНТЫ: диван 3-х, 3 1/2 местный. **СТРУКТУРА:** дерево и его производные, перекрещенные эластичные ремни высокой прочности. **НАБИВКА:** по умолчанию полиуретан средней жесткости (gomma), полистероловые волокна. По запросу можно изменить тип наполнения подушек сидения (за дополнительную плату). **ХАРАКТЕРИСТИКИ:** подушки в стоймость не входят; отделка подушек сидения и каркаса «bordino»; видимые ножки в серийных отделаках.

NISSOLIA

PAGINA 132



VERSIONI: 2 posti, 3 posti e 3 posti e mezzo. STRUTTURA: legno e suoi derivati, cinghie elastiche incrociate ad alta resistenza. IMBOTTITURA: in poliuretano espanso a quote e qualità differenziate, fibre poliestere. Su richiesta, è possibile personalizzare l'imbottitura. CARATTERISTICHE: cuscinetti di serie; seduta e struttura con bordino; piedi rivestiti.

VERSIONS: 2 seater sofa, 3 seater, 3 1/2 seater sofa. STRUCTURE: in wood and by-products, high resistant strength woven elastic belts. PADDING: expanded polyurethane of differentiated densities and qualities, polyester fibre. On request is possible choose the padding (additional cost). CHARACTERISTICS: goose feather pillows included.

ВАРИАНТЫ: диван 2-х, 3 1/2, 3-х местный. СТРУКТУРА: дерево и его производные, перекрещенные эластичные ремни высокой прочности. НАБИВКА: по умолчанию полиуретан средней жесткости (gomma), полистероловые волокна. По запросу можно изменить тип наполнения подушек сидения (за дополнительную плату). ХАРАКТЕРИСТИКИ: по умолчанию декоративные подушки; отделка подушек сидения и каркаса «bordino».

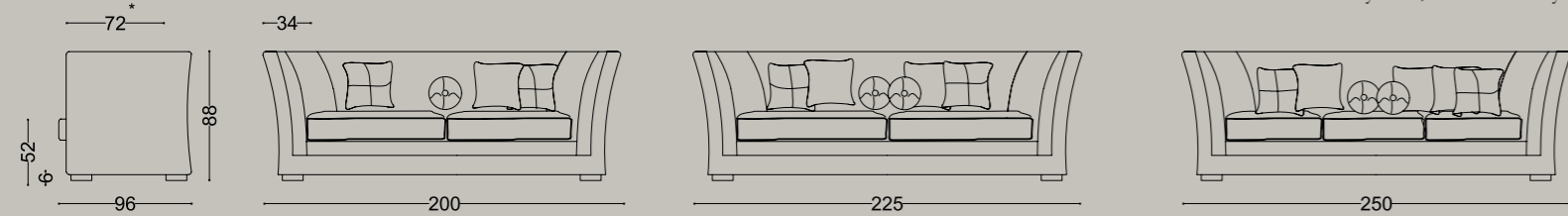

* MISURA SENZA CUSCINETTI

ONONIDE

PAGINA 78



VERSIONI: poltrona, 2 posti, 2 posti e mezzo, 3 posti e panca. STRUTTURA: legno e suoi derivati, cinghie elastiche incrociate ad alta resistenza. IMBOTTITURA: in poliuretano espanso a quote e qualità differenziate, fibre poliestere. Su richiesta, è possibile personalizzare l'imbottitura con relativi costi aggiuntivi. CARATTERISTICHE: i rulli della panca sono di serie; seduta e struttura con bordino; la finitura è disponibile nei colori previsti a catalogo.

VERSIONS: armchair, 2 seater sofa, 2 1/2 seater, 3 seater sofa and dormouse. STRUCTURE: in wood and by-products, high resistant strength woven elastic belts. PADDING: expanded polyurethane of differentiated densities and qualities, polyester fibre. On request is possible choose the padding (additional cost). CHARACTERISTICS: edge with border; wood finishing is available in different colors in the catalog.

ВАРИАНТЫ: кресло, диван 2-х, 2 1/2, 3-х местный, банкетка. СТРУКТУРА: дерево и его производные, перекрещенные эластичные ремни высокой прочности. НАБИВКА: по умолчанию полиуретан средней жесткости (gomma), полистероловые волокна. По запросу можно изменить тип наполнения подушек сидения (за дополнительную плату). ХАРАКТЕРИСТИКИ: у банкетки по умолчанию серийные валики; отделка подушек сидения и каркаса «bordino»; отделка в цветах, как в каталоге.

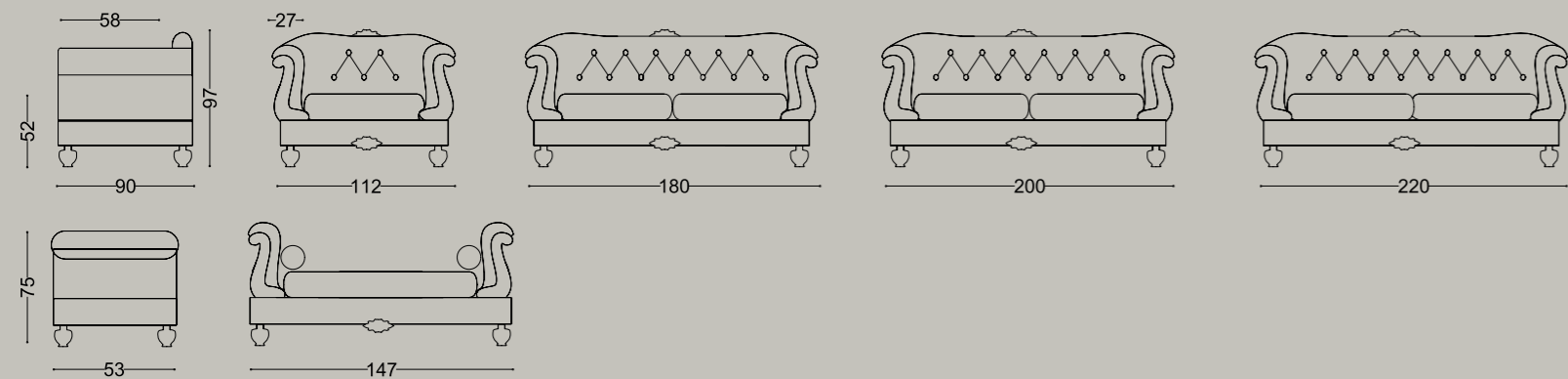

OSSALIDE

PAGINA 30



VERSIONI: 2 posti e mezzo, 3 posti. STRUTTURA: legno e suoi derivati, cinghie elastiche incrociate ad alta resistenza. IMBOTTITURA: in poliuretano espanso a quote e qualità differenziate, fibre poliestere. CARATTERISTICHE: cuscinetti di serie; seduta fissa; biscotti con bordino; piedi a vista, la finitura è disponibile nei colori previsti a catalogo.

VERSIONS: 2 1/2 seater, 3 seater sofa. STRUCTURE: in wood and by-products, high resistant strength woven elastic belts. PADDING: expanded polyurethane of differentiated densities and qualities, polyester fibre. CHARACTERISTICS: goose feather pillows included; visible legs colors provided in the catalog.

ВАРИАНТЫ: диван 2 1/2, 3-х местный. СТРУКТУРА: дерево и его производные, перекрещенные эластичные ремни высокой прочности. НАБИВКА: по умолчанию полиуретан средней жесткости (gomma), полистероловые волокна. ХАРАКТЕРИСТИКИ: по умолчанию декоративные подушки; несъемная подушка сидения; вставки в подлокотниках с отделкой «bordino»; видимые ножки в серийных отделах.

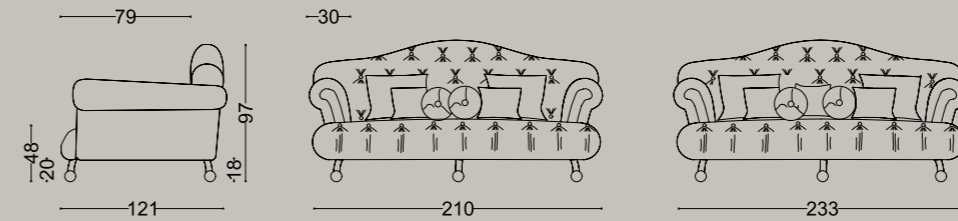

PARODIA

PAGINA 84



VERSIONI: pouf, poltrona, twin chair, 2 posti, 2 posti e mezzo, 3 posti. Il divano 2 posti, 2 posti e mezzo, 3 posti e' disponibile nella versione letto con rete elettrosaldata e materasso in fibra poliuretanic h 13 cm. STRUTTURA: legno e suoi derivati, cinghie elastiche incrociate ad alta resistenza. IMBOTTITURA: in poliuretano espanso a quote e qualità differenziate, fibre poliestere. Su richiesta, è possibile personalizzare l'imbottitura con relativi costi aggiuntivi. CARATTERISTICHE: cuscinetti optional; seduta e spalla con spazzolino; frangia sfilata in tinta al tessuto con art 1407 e art 1401 applicati facenti parte della collezione Rosa dei Venti disponibili nei colori previsti a catalogo. Pouf con piedi a vista dotati di ruote in ottone, la parte in legno e' disponibile nei colori previsti a catalogo; piano in vetro. Disponibile anche con balza.

VERSIONS: pouf, armchair, twin chair, 2 seater, 2 1/2 seater, 3 seater sofa. The 2 seater, 2 1/2 seater, 3 seater sofa is available in bed version with electrowelded frame and polyurethane mattress of 13 cm. STRUCTURE: in wood and by-products, high resistant strength woven elastic belts. PADDING: expanded polyurethane of differentiated densities and qualities, polyester fibre. On request is possible choose the padding (additional cost). CHARACTERISTICS: goose feather pillows optional; edge with brush; fringe as photo with art.1407 Rosa dei Venti collection in the colors provided in the catalog; pouf with visible legs colors provided in the catalog. Available with volant.

ВАРИАНТЫ: пуф, кресло, двойное кресло, диван 2-х, 2 1/2, 3-х местный. Диваны 2-х, 2 1/2, 3-х местные могут быть укомплектованы раскладным механизмом с металлической решеткой и полиуретановым матрасом 13 см. СТРУКТУРА: дерево и его производные, перекрещенные эластичные ремни высокой прочности. НАБИВКА: по умолчанию полиуретан средней жесткости (gomma), полистероловые волокна. По запросу можно изменить тип наполнения подушек сидения (за дополнительную плату). ХАРАКТЕРИСТИКИ: подушки в комплекте не входят; подушка сидения и спинки с отделкой «spazzolino»; декоративная гобка «frangia sfilata» в цвет ткани с арт.1407 и арт.1401 из коллекции Rosa dei Venti в цветах, как в каталоге. У пуфа видимые лапчатые ножки с колесами, окраска лакированных элементов в серийных отделах, стеклянная столешница. Возможно также декоративная гобка.

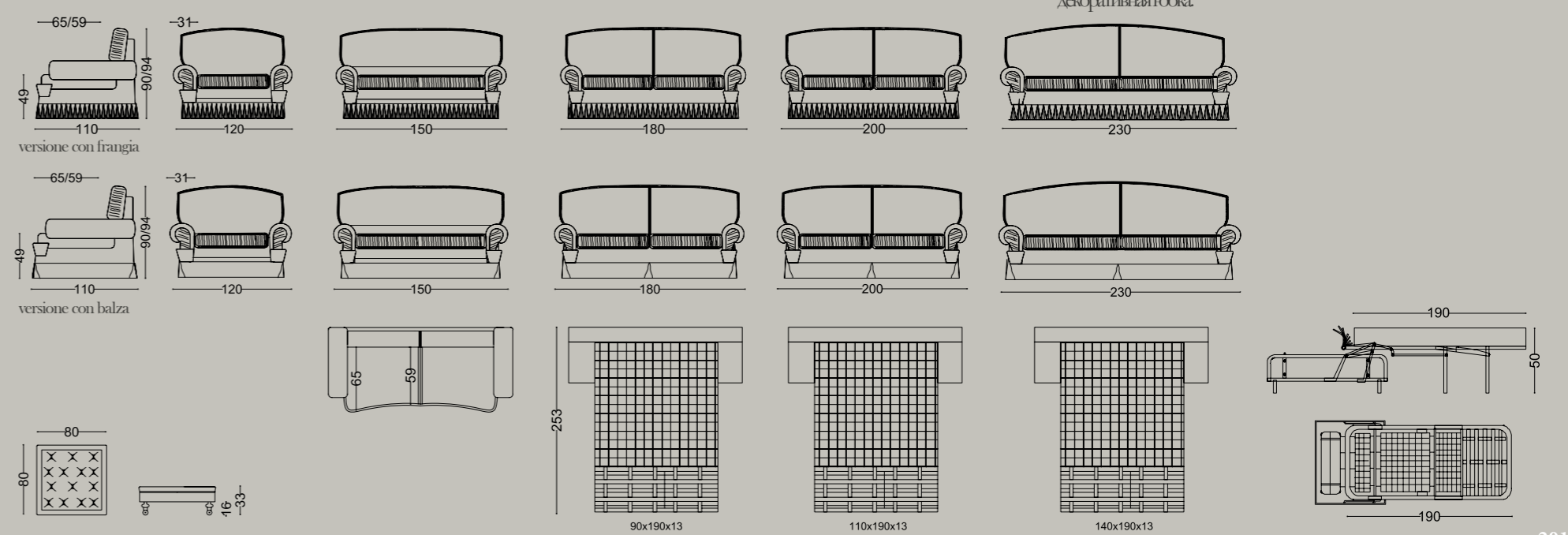

PERVINCA

PAGINA 29

VERSIONI: poltrona. STRUTTURA: legno e suoi derivati, cinghie elastiche incrociate ad alta resistenza. IMBOTTITURA: in poliuretano espanso a quote differenziate, fibre poliestere. CARATTERISTICHE: con balza; con passamaneria della collezione Palais Royal disponibile nei colori previsti a catalogo.

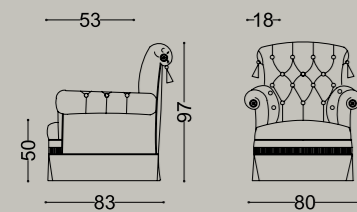

VERSIONS: armchair. STRUCTURE: in wood and by-products, high resistant strength woven elastic belts. PADDING: expanded polyurethane of differentiated densities and qualities, polyester fibre. CHARACTERISTICS: with volant and trimmings Palais Royal in the colors provided in the catalog included.

ВАРИАНТЫ: кресло. СТРУКТУРА: дерево и его производные, перекрещенные эластичные ремни высокой прочности. НАБИВКА: по умолчанию полиуретан средней жесткости (готта), полистероловые волокна. ХАРАКТЕРИСТИКИ: по умолчанию декоративная тобка; несъемная подушка сидения; басонные изделия из коллекции Palais Royal в цветах, как в каталоге.

POLIGALA

PAGINA 144

VERSIONI: 2 posti, 2 posti e mezzo e 3 posti. STRUTTURA: legno e suoi derivati, cinghie elastiche incrociate ad alta resistenza. IMBOTTITURA: in poliuretano espanso a quote e qualità differenziate, fibre poliestere. Su richiesta, è possibile personalizzare l'imbottitura. CARATTERISTICHE: cuscineti optional; seduta e struttura con bordino; piedi a vista, la finitura è disponibile nei colori previsti a catalogo.

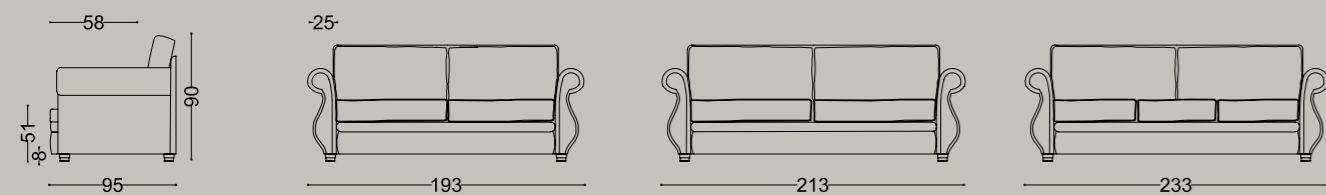

VERSIONS: 2 seater sofa, 2½ seater sofa and 3 seater sofa. STRUCTURE: in wood and by-products, high resistant strength woven elastic belts. PADDING: expanded polyurethane of differentiated densities and qualities, polyester fibre. On request is possible choose the padding (additional cost). CHARACTERISTICS: pillows optional; edge with border; visible legs, colors provided in the catalog.

ВАРИАНТЫ: диван 2-х, 2 ½, 3-х местный. СТРУКТУРА: дерево и его производные, перекрещенные эластичные ремни высокой прочности. НАБИВКА: по умолчанию полиуретан средней жесткости (готта), полистероловые волокна. По запросу можно изменить тип наполнения подушек сидения (за дополнительную плату). ХАРАКТЕРИСТИКИ: подушки в стоимость не входят; отделка подушек сидения и каркаса «fordino»; видимые ножки в серийных отделах.

REBUTIA

PAGINA 118

VERSIONI: 2 posti, 3 posti e 3 posti e mezzo. STRUTTURA: legno e suoi derivati, cinghie elastiche incrociate ad alta resistenza. IMBOTTITURA: in poliuretano espanso a quote e qualità differenziate, fibre poliestere. Su richiesta, è possibile personalizzare l'imbottitura. CARATTERISTICHE: cuscineti optional; seduta e struttura con bordino; con frangia e fiocchettata in cotone. Disponibile con i piedi a vista nei colori previsti a catalogo.

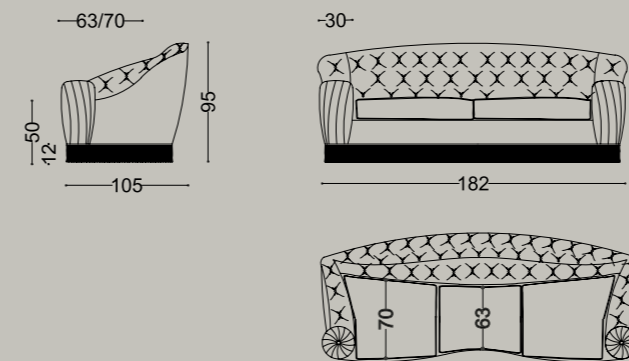

VERSIONS: 2 seater sofa, 3 seater, 3½ seater sofa. STRUCTURE: in wood and by-products, high resistant strength woven elastic belts. PADDING: expanded polyurethane of differentiated densities and qualities, polyester fibre. On request is possible choose the padding (additional cost). CHARACTERISTICS: pillows optional; edge with border. Available with visible legs colors provided in the catalog.

ВАРИАНТЫ: диван 2-х, 3 ½, 3-х местный. СТРУКТУРА: дерево и его производные, перекрещенные эластичные ремни высокой прочности. НАБИВКА: по умолчанию полиуретан средней жесткости (готта), полистероловые волокна. По запросу можно изменить тип наполнения подушек сидения (за дополнительную плату). ХАРАКТЕРИСТИКИ: подушки в стоимость не входят; отделка подушек сидения и каркаса «fordino»; декоративная бахромчатая тобка «frangia» с отделкой «fiocchettata» из хлопка. Возможны видимые ножки в серийных отделах.

ROMICE

PAGINA 72

VERSIONI: poltrona, 2 posti, 2 posti e mezzo, 3 posti, 3 posti e mezzo. Il divano 2 posti, 2 posti e mezzo, 3 posti e 3 posti e mezzo e' disponibile nella versione letto con rete elettrosaldata e materasso in fibra poliuretanicca h 13 cm. STRUTTURA: legno e suoi derivati, cinghie elastiche incrociate ad alta resistenza. IMBOTTITURA: in poliuretano espanso a quote e qualità differenziate, fibre poliestere. Su richiesta, è possibile personalizzare l'imbottitura con relativi costi aggiuntivi. CARATTERISTICHE: cuscineti di serie; seduta e struttura con bordino; fascia cuscini seduta e cordolo bracciolo plissetata; con balza.

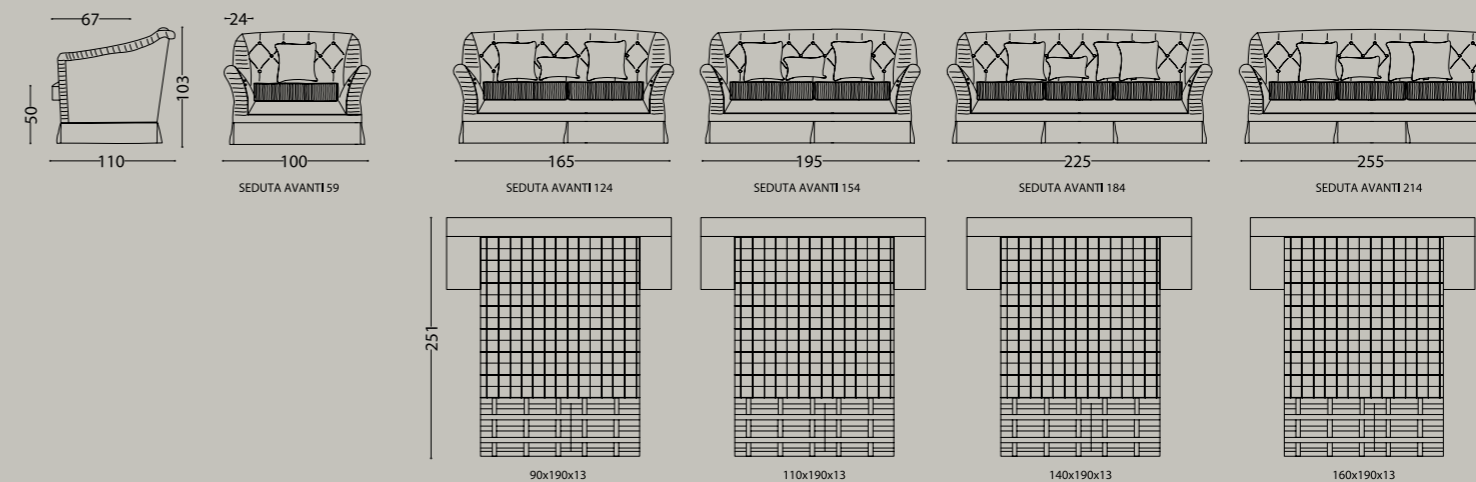

VERSIONS: armchair, 2 seater, 2½ seater, 3 seater sofa, 3½ seater sofa. The 2 seater, 2½ seater, 3 seater sofa, 3½ seater sofa is available in bed version with electrowelded frame and polyurethane mattress of 13 cm. STRUCTURE: in wood and by-products, high resistant strength woven elastic belts. PADDING: expanded polyurethane of differentiated densities and qualities, polyester fibre. On request is possible choose the padding (additional cost). CHARACTERISTICS: goose feather pillows included; edge with border; with volant.

ВАРИАНТЫ: кресло, диван 2-х, 2 ½, 3-х, 3 ½ местный. Диваны 2-х, 2 ½, 3-х, 3 ½ местные могут быть укомплектованы раскладным механизмом с металлической решеткой и полиуретановым матрасом 13 см. СТРУКТУРА: дерево и его производные, перекрещенные эластичные ремни высокой прочности. НАБИВКА: по умолчанию полиуретан средней жесткости (готта), полистероловые волокна. По запросу можно изменить тип наполнения подушек сидения (за дополнительную плату). ХАРАКТЕРИСТИКИ: по умолчанию серийные подушки; отделка подушек сидения и каркаса «fordino»; лицевая часть подушки сидения плетенованная; декоративная тобка.

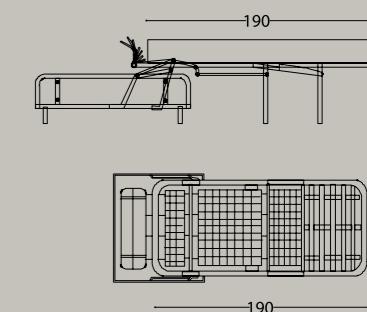

SILENA

PAGINA 138

VERSIONI: 2 posti, 2 posti e mezzo e 3 posti. STRUTTURA: legno e suoi derivati, cinghie elastiche incrociate ad alta resistenza. IMBOTTITURA: in poliuretano espanso a quote e qualità differenziate, fibre poliestere. Su richiesta, è possibile personalizzare l'imbottitura. CARATTERISTICHE: cuscinetti in piuma di serie; seduta e struttura con bordino; frangia maderata e cordone alla base.

VERSIONS: 2 seater sofa, 2 1/2 seater, 3 seater sofa. STRUCTURE: in wood and by-products, high resistant strength woven elastic belts. PADDING: expanded polyurethane of differentiated densities and qualities, polyester fibre. On request is possible choose the padding (additional cost). CHARACTERISTICS: goose feather pillow included.

ВАРИАНТЫ: диван 2-х, 2 1/2, 3-х местный. СТРУКТУРА: дерево и его производные, перекрещенные эластичные ремни высокой прочности. НАБИВКА: по умолчанию полиуретан средней жесткости (gomma), полистероловые волокна. По запросу можно изменить тип наполнения подушек сидения (за дополнительную плату). ХАРАКТЕРИСТИКИ: по умолчанию серийные декоративные подушки; отделка подушек сидения и каркаса «bordino»; декоративная бахромчатая юбка с отделкой «cordone».

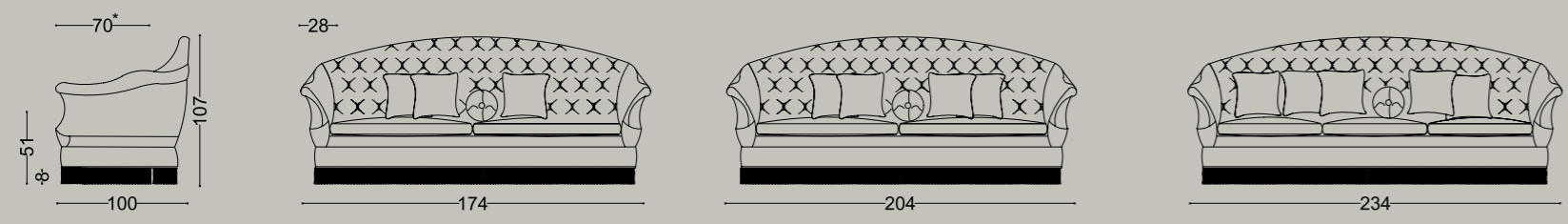

* MISURA SENZA CUSCINETTI

STACHIS

PAGINA 28

VERSIONI: poltrona e 2 posti. STRUTTURA: legno e suoi derivati. IMBOTTITURA: in poliuretano espanso a quote e qualità differenziate, fibre poliestere. CARATTERISTICHE: seduta e struttura con bordino; piedi a vista, la finitura e' disponibile nei colori previsti a catalogo.

VERSIONS: armchair and 2 seater sofa. STRUCTURE: in wood and by-products. PADDING: expanded polyurethane of differentiated densities and qualities, polyester fibre. CHARACTERISTICS: edge with border; visible legs, colors provided in the catalog.

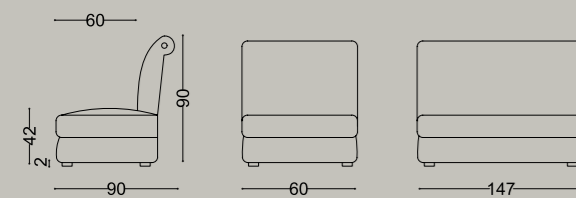

TAJOLA

PAGINA 38

VERSIONI: poltrona, 2 posti, 2 posti e mezzo, 3 posti. STRUTTURA: legno e suoi derivati, cinghie elastiche incrociate ad alta resistenza. IMBOTTITURA: in poliuretano espanso a quote e qualità differenziate, fibre poliestere. CARATTERISTICHE: cuscinetti optional; seduta fissa; struttura con bordino; piedi a vista, la finitura e' disponibile nei colori previsti a catalogo.

VERSIONS: armchair, 2 seater, 2 1/2 seater, 3 seater sofa. STRUCTURE: in wood and by-products, high resistant strength woven elastic belts. PADDING: expanded polyurethane of differentiated densities and qualities, polyester fibre. CHARACTERISTICS: goose feather pillows optional; edge with border; visible legs colors provided in the catalog.

ВАРИАНТЫ: кресло, диван 2-х, 2 1/2, 3-х местный. СТРУКТУРА: дерево и его производные, перекрещенные эластичные ремни высокой прочности. НАБИВКА: по умолчанию полиуретан средней жесткости (gomma), полистероловые волокна. ХАРАКТЕРИСТИКИ: подушки в стоимость не входят; по умолчанию несъемная подушка сидения; отделка каркаса «bordino»; видимые ножки в серийных отделах.

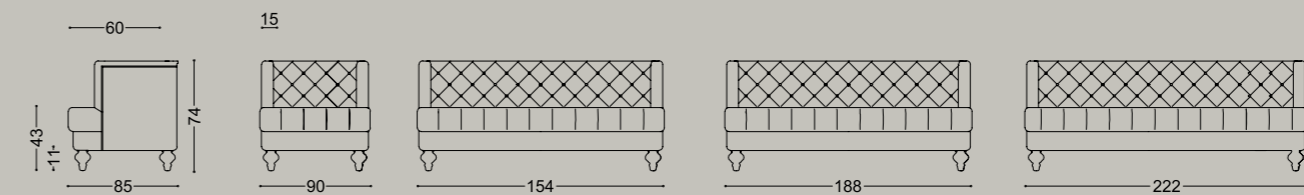

VERBASCO

PAGINA 52

VERSIONI: pouf 110x60, pouf 110x110, poltrona, 2 posti, 2 posti e mezzo e 3 posti. Il divano 2 posti, 2 posti e mezzo, 3 posti e' disponibile nella versione letto con rete elettrosaldata e materasso in fibra poliuretana h 13 cm. STRUTTURA: legno e suoi derivati, cinghie elastiche incrociate ad alta resistenza. IMBOTTITURA: in poliuretano espanso a quote e qualità differenziate, fibre poliestere. Su richiesta, è possibile personalizzare l'imbottitura con relativi costi aggiuntivi. CARATTERISTICHE: cuscinetti di serie con imbottitura in piuma; seduta con bordino; struttura con cordone art 1200 collezione Calde Atmosfere; con balza e frangia art 1204 della collezione Calde Atmosfere disponibile nei colori previsti a catalogo. Disponibile anche con balza.

VERSIONS: pouf 110x60, pouf 110 x 110, armchair, 2 seater, 2 1/2 seater, 3 seater sofa. The 2 seater, 2 1/2 seater, 3 seater sofa is available in bed version with electrowelded frame and polyurethane mattress of 13 cm. STRUCTURE: in wood and by-products, high resistant strength woven elastic belts. PADDING: expanded polyurethane of differentiated densities and qualities, polyester fibre. On request is possible choose the padding (additional cost). CHARACTERISTICS: goose feather pillows included; Volant and fringe art.1204 Calde Atmosfere collection in the colors provided in the catalog. Available with volant.

ВАРИАНТЫ: пуф 110x60, пуф 110x110, кресло, диван 2-х, 2 1/2, 3-х местный. Диваны 2-х, 2 1/2, 3-х местные могут быть укомплектованы раскладным механизмом с металлической решеткой и полиуретановым матрасом 13 см. СТРУКТУРА: дерево и его производные, перекрещенные эластичные ремни высокой прочности. НАБИВКА: по умолчанию полиуретан средней жесткости (gomma), полистероловые волокна. По запросу можно изменить тип наполнения подушек сидения (за дополнительную плату). ХАРАКТЕРИСТИКИ: по умолчанию декоративные подушки из пуха; подушка сидения с отделкой «bordino»; каркас с отделкой «cordone» арт.1200 из коллекции Calde Atmosfere; декоративная юбка с басонными изделиями арт.1204 из коллекции Calde Atmosfere в цветах, как в каталоге. Возможна также декоративная юбка.

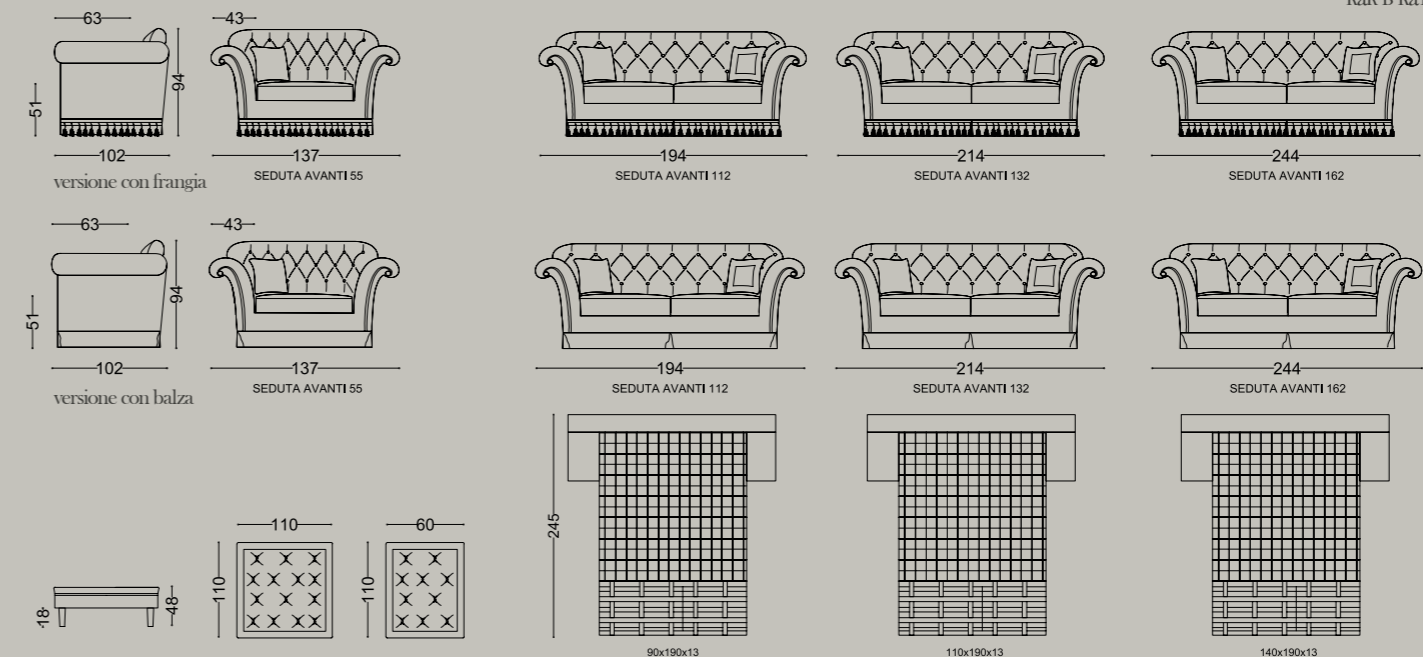

EUFORBIA

PAGINA 50

VERSIONI: dormouse. STRUTTURA: legno di faggio. IMBOTTITURA: in poliuretano espanso a quote e qualità differenziate, fibre poliestere. CARATTERISTICHE: fissa con bordino; la finitura è disponibile nei colori previsti a catalogo.

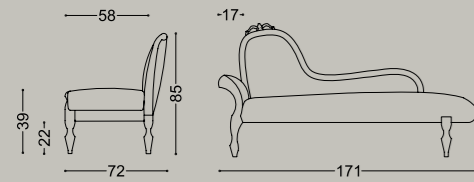

VERSIONS: dormouse. STRUCTURE: in wood and by-products. PADDING: expanded polyurethane of differentiated densities and qualities, polyester fibre. CHARACTERISTICS: wood finishing is available in different colors in the catalog.

ВАРИАНТЫ: кушетка. СТРУКТУРА: дерево бук. НАБИВКА: по умолчанию полиуретан средней жесткости (gomma), полистероловые волокна. ХАРАКТЕРИСТИКИ: фиксированная; отделка «bordino»; окраска деревянных элементов в серийных оттенках.



FARFARO

PAGINA 110

VERSIONI: pouf. STRUTTURA: legno e suoi derivati. IMBOTTITURA: in poliuretano espanso a quote e qualità differenziate, fibre poliestere. CARATTERISTICHE: struttura con trinetta; cuscino con cordone nella parte superiore e nella parte inferiore passamaneria art.33025 della collezione Valmont nei colori previsti a catalogo; base in legno nelle finiture disponibili a catalogo.



VERSIONS: pouf. STRUCTURE: in wood and by-products. PADDING: expanded polyurethane of differentiated densities and qualities, polyester fibre. CHARACTERISTICS: wood finishing is available in different colors in the catalog.

ВАРИАНТЫ: пуф. СТРУКТУРА: дерево и его производные. НАБИВКА: по умолчанию полиуретан средней жесткости (gomma), полистероловые волокна. ХАРАКТЕРИСТИКИ: отделка каркаса «trinetta», верхняя часть подушки с отделкой «cordone», нижняя с басонными изделиями арт.33025 из коллекции Valmont в цветах, как в каталоге; окраска деревянных элементов в серийных оттенках.



SEDUM

PAGINA 90

VERSIONI: pouf. STRUTTURA: legno e suoi derivati. IMBOTTITURA: in poliuretano espanso a quote e qualità differenziate, fibre poliestere. CARATTERISTICHE: interamente rivestito; chiodini nei colori previsti a catalogo.

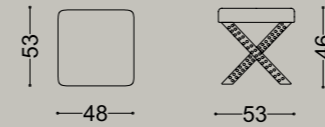

VERSIONS: pouf. STRUCTURE: in wood and by-products. PADDING: expanded polyurethane of differentiated densities and qualities, polyester fibre. CHARACTERISTICS: nails included in same colors and typology in catalog.

ВАРИАНТЫ: пуф. СТРУКТУРА: дерево и его производные. НАБИВКА: по умолчанию полиуретан средней жесткости (gomma), полистероловые волокна. ХАРАКТЕРИСТИКИ: полностью обтянут тканью; гвоздики в цветах, как в каталоге.



ZINIA

PAGINA 14

VERSIONI: pouf d.61, d.90 e d.117. STRUTTURA: legno e suoi derivati. CARATTERISTICHE: profili in cordone.

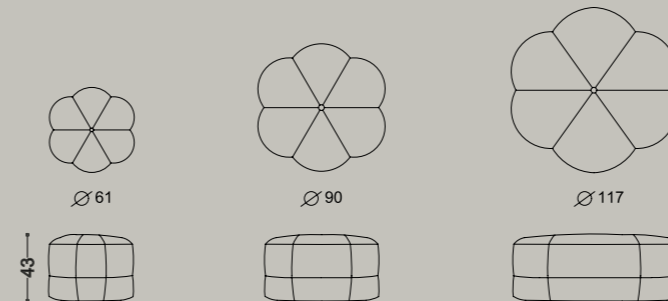

VERSIONS: pouf d.61, d.90 and d.117. STRUCTURE: in wood and by-products. CHARACTERISTICS: edge with cordon rope.

ВАРИАНТЫ: пуф d.61, d.90, d.117. СТРУКТУРА: дерево и его производные. ХАРАКТЕРИСТИКИ: по умолчанию отделка «cordone».



IMBOTTITURA CUSCINI SEDUTA

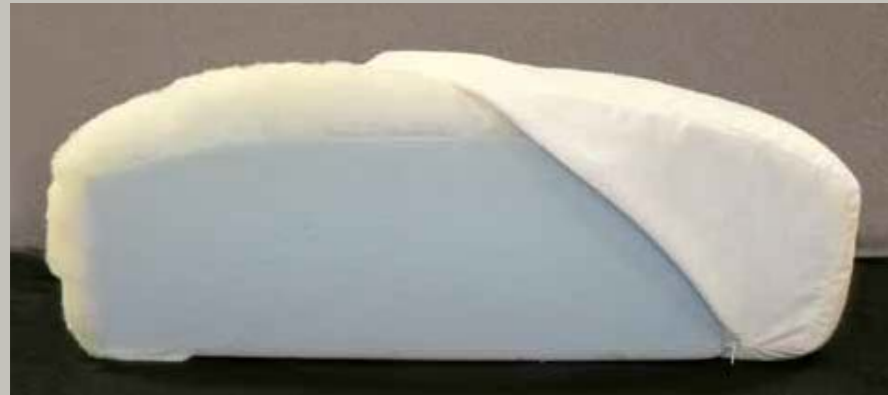

CUSCINO IN POLIURETANO 35RS STANDARD



CUSCINO IN POLIURETANO WATERLILY (OPZIONE)

Particolarmente confortevole ed indeformabile ha nelle sue caratteristiche tecniche materie prime ecologiche a base di acqua. Seduta esclusiva e brevettata studiata dal nostro ufficio tecnico a sostegno inferiore in densità 35 che dona più stabilità alla seduta. E' possibile utilizzarlo su richiesta, su tutte le sedute dei modelli con modesto costo aggiuntivo.



CUSCINO IN PIUMA D'OCA PIUMEX (OPZIONE)

Imbottitura cuscino con strato superiore in piuma con tela spigata 100% cotone suddivisa in zone a pesi differenziati e base inferiore in poliuretano speciale. Questa soluzione, studiata e mixata dal nostro ufficio tecnico, permette di ottenere il comfort della piuma e un' adeguata stabilità della seduta. E' possibile utilizzarlo su tutti i modelli con lieve costo aggiuntivo.



CUSCINO IN PIUMA D'OCA DOPPIO STRATO (OPZIONE)

Imbottitura cuscini piuma con tela spigata 100% cotone suddivisa in zone a pesi differenziati. Interno in piuma d'oca, con uno strato centrale di waterlily. Sistema esclusivo studiato dal nostro ufficio tecnico che permette di avere il massimo comfort della piuma, lasciando quasi invariata l'estetica del cuscino che grazie al waterlily ritorna perfettamente intatto. E' possibile utilizzarlo su tutti i modelli con moderato costo aggiuntivo.



CUSCINO IN POLIURETANO 50 VISCOELASTICO MEMORY (OPZIONE)

Garantito nel tempo, molto confortevole ha nelle sue caratteristiche una seduta soft ed ergonomica che assume qualunque forma del corpo rendendo la seduta molto gradevole. La stessa è dotata di una particolare memoria che permette di riassumere la posizione iniziale; ha un sostegno inferiore che dona più stabilità alla seduta. E' possibile utilizzarlo su richiesta, su tutte le sedute dei modelli con lieve costo aggiuntivo.

collection art direction
Vincenzo Merli

project director
Margherita Cicirelli

graphic design
Leonardi Marinelli architetti

art buyer
Giorgia Angelini

foto
Leonfoto.it

stampa
Stampa Sud spa

Ringraziamo Tecnografica
per le carte da parati



